

Machine configuration

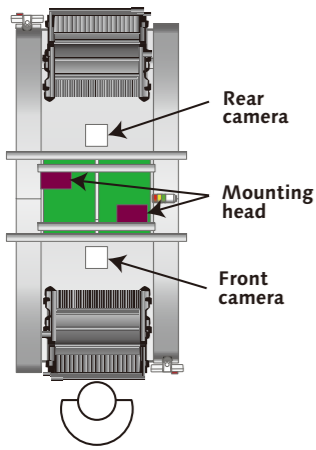

Supply unit layout

Layout 1	Layout 2	Layout 3	Layout 4	Layout 5
8 mm taping : 120 Tray : 0	8 mm taping : 136 Tray : 0	8 mm taping : 94 Tray : 24	8 mm taping : 102 Tray : 24	8 mm taping : 68 Tray : 48
TF30	TF17 TF17	TF17 Tray	TF17 Tray	TF17 Tray
TF30	TF17 TF17	TF30	TF17 TF17	Tray TF17

Model ID	NPM-WX								
Model No.	NM-EJM9D								
PCB dimensions	Single-lane mode	Batch mounting : L 50 mm × W 50 mm to L 750 mm × W 610 mm				2 position mounting : L 50 mm × W 50 mm to L 350 mm × W 610 mm			
	Dual-lane mode	Dual transfer (Batch) : L 50 mm × W 50 mm to L 750 mm × W 300 mm				Dual transfer (2 position) : L 50 mm × W 50 mm to L 350 mm × W 300 mm			
Electric source	3-phase AC 200 , 220 , 380 , 400 , 420 , 480 V 3.0 kVA								
	Pneumatic source ^{*1} / Min.0.5 MPa、200 L / min (A.N.R.)								
Dimensions ^{*2}	W 1 410 mm × D 2 588 mm × H 1 444 mm ^{*3} / W 1 410 mm × D 2 318 mm × H 1 444 mm ^{*4}								
Mass	3 120 kg ^{*3} / 3 050 kg ^{*4}								
Placement head	Lightweight 16-nozzle head V3A (Per head)		Lightweight 8-nozzle head (Per head)		4-nozzle head (Per head)		3-nozzle head V2 (Per head)		
	High-accuracy mode [OFF]	High-accuracy mode [ON]	High-accuracy mode [OFF]	High-accuracy mode [ON]	High-accuracy mode [OFF]	High-accuracy mode [ON]	High-accuracy mode [OFF]	High-accuracy mode [ON]	
Placement speed ^{*5} * at optimum conditions	47 000 cph (0.077 s / chip)	35 000 cph (0.103 s / chip)	23 000 cph (0.155 s / chip)	18 000 cph (0.200 s / chip)	8 400 cph (0.429 s / chip)	6 500 cph (0.554 s / chip)	9 400 cph (0.383 s / chip)	7 000 cph (0.514 s / chip)	
					7 800 cph (0.462 s / QFP feeder)	7 300 cph (0.493 s / QFP feeder)	7 300 cph (0.493 s / QFP feeder)	7 000 cph (0.514 s / chip)	
Placement accuracy (Cpk ≥ 1) * at optimum conditions	± 25 μm / chip	± 15 μm / chip	± 25 μm / chip	± 15 μm / chip	± 20 μm / QFP	± 15 μm / chip	± 20 μm / QFP	± 15 μm / chip	
Component dimensions (mm)	0201 chip ^{-8,9} / 03015 chip ⁻⁸		0402 chip ⁻⁸ to L 45 × W 45 × T 12		0603 chip to L 120 × W 90 × T 40 / T 45 ⁻¹¹		0603 chip to L 120 × W 90 × T 40 / T 45 ⁻¹¹		
	0402 chip ⁻⁸ to L 8.5 × W 8.5 × T 3 / T 6 ⁻¹⁰		or L 100 × W 40 × T 12		or L 150 × W 25 × T 40 / T 45 ⁻¹¹		or L 150 × W 25 × T 40 / T 45 ⁻¹¹ or L 135 × W 135 × T 18 ⁻¹²		
Component supply	Taping		Tape : 4 to 56 / 72 mm		Tape : 4 to 56 / 72 / 88 / 104 mm				
	Stick		Max.32 (single stick feeder)						
	Tray		Max.144 (Front-rear tray stocker specifications)						

Please refer to the specification booklet for details.

*4 : Dimensions and mass of the machine and two ASF⁻¹⁴ carts (60-slot). They differ depending on the optional configuration.

*10 : T 6 needs dedicated short nozzles and is □6.5 mm or less.

*1 : Only for main body

*5 : For any QFP □20 mm or less in size

*6 : For any QFP □28 mm or less in size

*7 : The placement angle recognition setting needs to be enabled.

*8 : 0201 / 03015 / 0402 component requires a specific nozzle / tape feeder.

*9 : 0201 component placement is optional.

(Under conditions specified by Panasonic)

*11 : T 45 is option. (PCB thickness + Max component height ≤ T 53 ; so, for T 45, the max PCB thickness is 8.0 mm)

*12 : □135 mm is option.

*13 : Intelligent Tape Feeder

*14 : Auto Setting Feeder

⚠ Safety Cautions

- Please read the User's Manual carefully to familiarize yourself with safe and effective usage procedures.
- To ensure safety when using this equipment, all work should be performed according to that as stated in the supplied Operating Instructions. Read your operating instruction manual thoroughly.

Panasonic Group products are built with the environment in mind.

For details here



Panasonic GREEN IMPACT

Inquiries...

Panasonic Connect Co., Ltd.
Circuit Formation Process Business Division

3-1-1 Inazu-cho, Toyonaka City, Osaka
561-0854, Japan

All data as of January 16, 2025

Ver. January 16, 2025

© Panasonic Connect Co., Ltd. 2025

● Changes in specifications and appearance may be made without notice for product improvement.

● Please contact us via our website at <https://industrial.panasonic.com/ww/tr/fw>

Panasonic CONNECT

2025

Electronics Assembly System

Modular Placement Machine
Catalogue

Model ID

NPM-WX

Model No.

NM-EJM9D



NPM X



*It may not conform to Machinery Directive and EMC Directive in case of optional configuration and custom-made specification.

"Autonomous Factory" Concept *

A factory that immediately responds to every situation and continues to evolve autonomously
Ensuring the production of non-defective items through the integrated control of autonomous uninterrupted mounting lines and floors independent of any human intervention and judgment



*Under development toward the realization of the concept

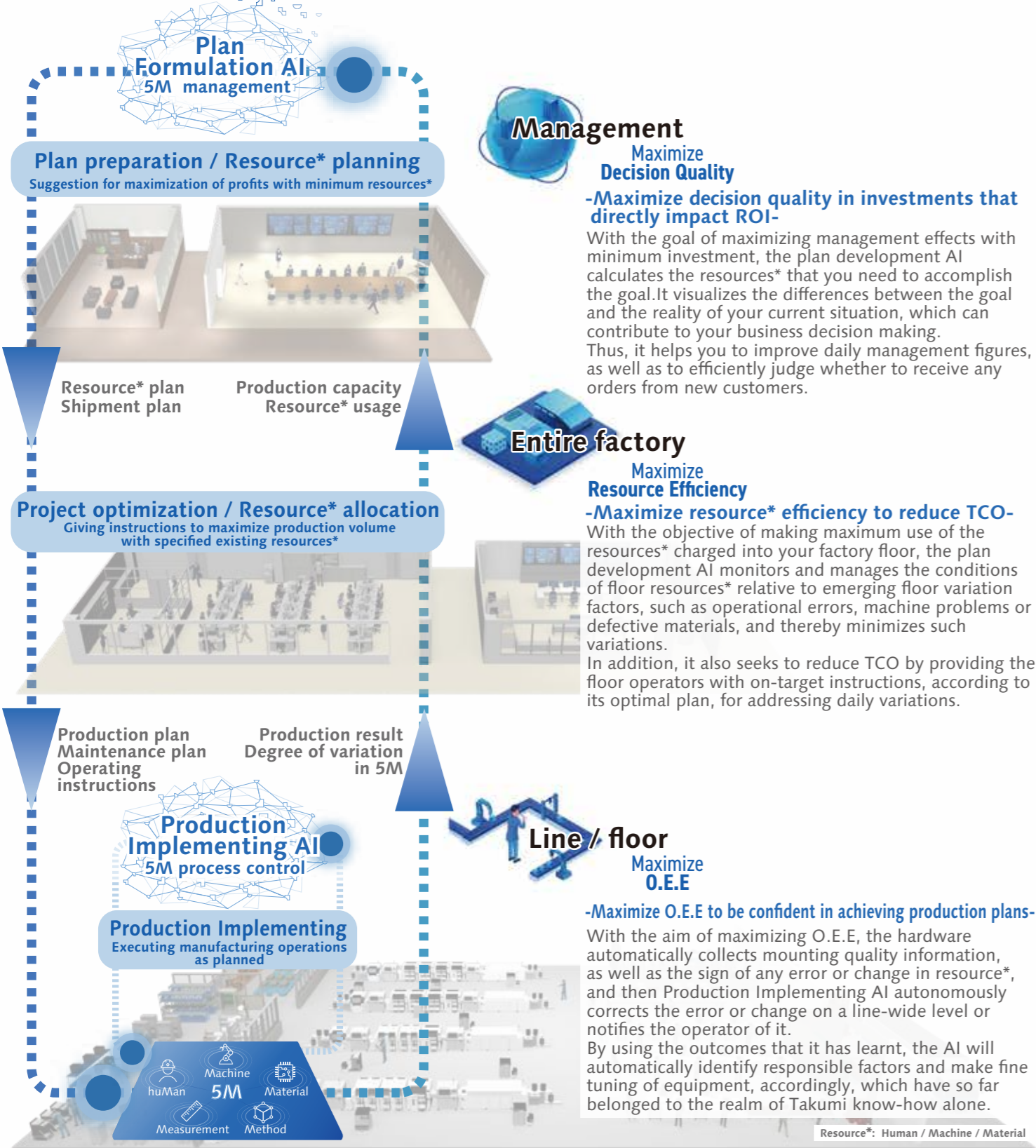

Resource*: Human / Machine / Material

Automation / Labor-saving Solution + Intelligent system Solution to Achieve Manufacturing That Is Further in Line with Production Plan

iLNB-based "Seamless SMT Line" Control

iLNB Well-established alliance network
Machines from 134* partners are connectable.
*According to a survey by us as of January, 2025

Automation Labor-saving

Intelligent system

Print Automated supply	Mount Automated supply	Mount Labor-saving supply
<h4 style="background-color: #0070C0; color: white; padding: 2px;">Screen printer</h4> <p>Fully automated printing process to ensure increased production time and production of non-defective items and, by means of that, to maximize O.E.E.</p> <ul style="list-style-type: none"> ● Solder transfer <div style="display: flex; justify-content: space-around;"> <div style="text-align: center;"> <p>Before retrieval</p> </div> <div style="text-align: center;"> <p>After retrieval</p> </div> </div> ● Metal Mask changer <p style="text-align: right; font-size: small;">*NPM-GP/L option</p>	<h4 style="background-color: #0070C0; color: white; padding: 2px;">ASF^{*1}</h4> <ul style="list-style-type: none"> • Paper and embossed tapes of all widths can be used.^{*2} • Automated loading of new component tapes requires no special skills. • LU^{*3} enables component tapes to be resupplied automatically without need for splicing. <div style="display: flex; justify-content: space-around;"> <div style="text-align: center;"> <p>ASF-1 (Standard)</p> </div> <div style="text-align: center;"> <p>ASF-1 (With LU^{*3} installed)</p> </div> </div> <div style="display: flex; justify-content: space-around;"> <div style="text-align: center;"> <p>Tape resupply (Standard)</p> </div> <div style="text-align: center;"> <p>Tape resupply (With LU^{*3} installed)</p> </div> </div> <ul style="list-style-type: none"> • Tapes can be loaded with a single button press, streamlining work processes to resupply components. • Components can be resupplied at any time in a skill-less manner. <p style="font-size: x-small;">*1: Auto Setting Feeder *2: ASF for 4 mm tape currently under development *3: Loading Unit</p>	<h4 style="background-color: #0070C0; color: white; padding: 2px;">Tray stocker</h4> <ul style="list-style-type: none"> • Replacing / refilling with tray magazines without having to stop the machine. • Labor-saving by reducing the frequency of refilling of magazines. <div style="text-align: center;"> </div> <p style="text-align: center; background-color: #0070C0; color: white; padding: 2px;">Tray stocker specifications : Max.72</p> <p style="text-align: right; font-size: x-small;">*NPM-WX option</p>

Line Intelligent system

Process control APC-5M^{*1}

By monitoring real-time "5M conditions" and "machine operating conditions," the AI detects any variations or changes in 5M for a line and performs more intelligent 5M process control and predictive maintenance of the line and, by that, realizes production of non-defective items and stable operation of in-line machines.

*1:5M (huMan / Machine / Material / Method / Measurement)
*2:Currently under development

Maximizing O.E.E (Overall Equipment Effectiveness)

APC-5M Production Implementing AI^{*2}

Status Monitoring

Corrections

APC-5M responds to problems quickly, checks outcomes, repeats self-verification / learning, accumulates experiences and thereby improves its problem-solving skills.

Realization of Autonomous Mounting Line

NPM-WX's features

New platform to realize Smart Manufacturing



NPM-WX

1 Evolved basic performance

2 Maximized actual throughput

3 Minimization of human-dependent work

1 Evolved basic performance

Increased productivity / quality

[High-accuracy mode OFF]
 Max.speed : 94 000 cph*
 IPC9850 (1608) : 67 000 cph*
 Max.speed : ± 25 μm

[High-accuracy mode ON]
 Max.speed : 70 000 cph*
 IPC9850 (1608) : 48 000 cph*
 Placement accuracy : ± 15 μm

* : Tact for Lightweight 16NH V3A × 2 head



Improved ability to support components

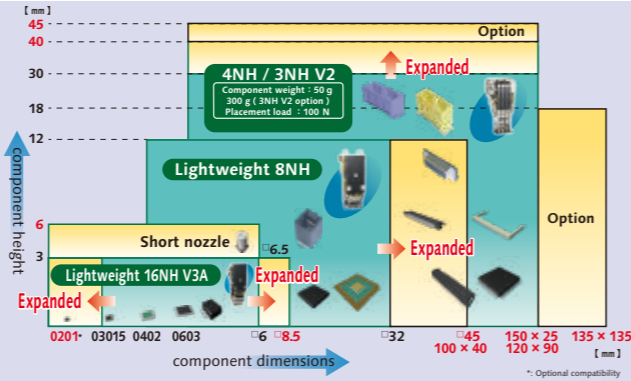

Increased PCB adaptability

Increase in transportable PCB size. (The following figures show increases compared to NPM-W2.)

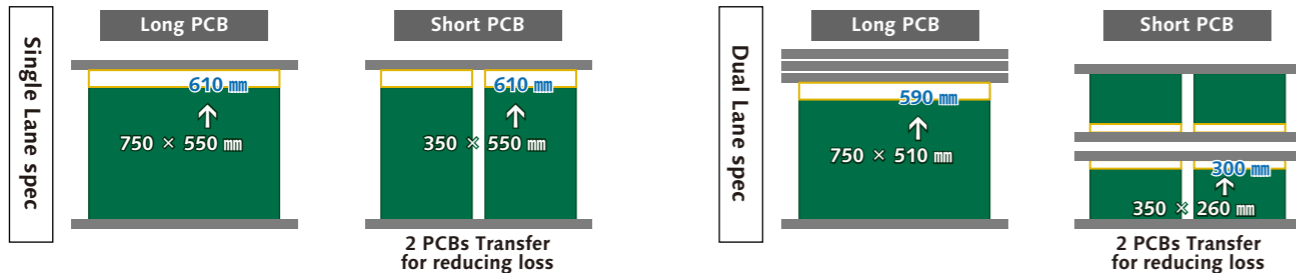

Greater versatility in supply units

Its overall versatility has been enhanced as it now allows you to make the following exchanges on your own.

- Exchanging ITF¹ cart (30-slot) for ASF² cart (60-slot)
- Exchanging ITF¹ cart (17-slot) / ASF² cart (34-slot) for single tray feeder (24-product type)

A tray stocker (72-product type), which can reduce the frequency of tray component feeding, is also installable.

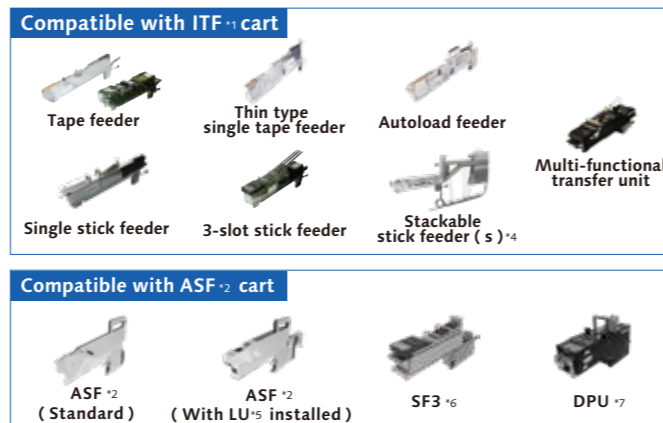
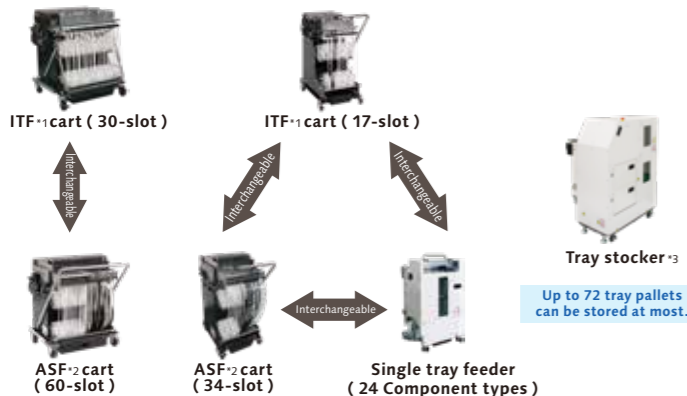

*1 : Intelligent Tape Feeder *2 : Auto Setting Feeder *3 : The dedicated tray feeder is necessary.
 *4 : L-sized one is available separately, depending on the component size. *5 : Loading Unit *6 : Stick Feeder 3-slot *7 : Dipping Unit

2 Maximized actual throughput

APC system

APC-5M: Real-time unit monitoring

APC-5M monitors the conditions of target units in real time and provides notification of the timing of maintenance of each unit or any error condition that could interrupt production, depending on variations in monitored unit values. This function enables you to conduct maintenance at optimal times.

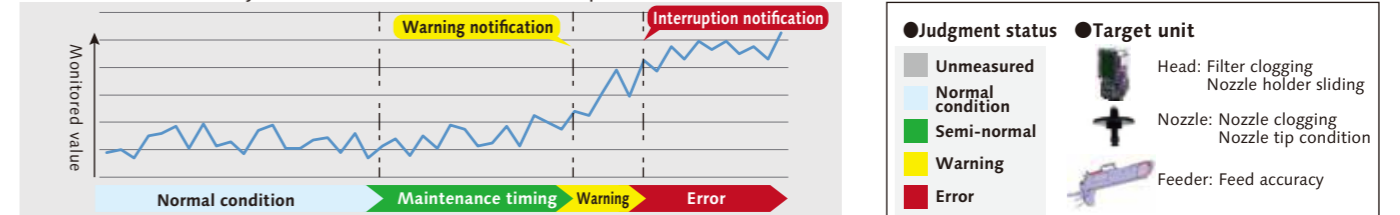

APC-FB¹ Feedback to the printing machine

Based on the analyzed measurement data from solder inspections, it corrects printing positions. (X, Y, θ)

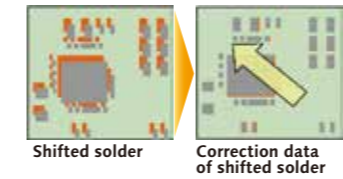

APC-FF¹ Feedforward to the placement machine

It analyzes solder position measurement data, and corrects component placement positions (X, Y, θ) accordingly.

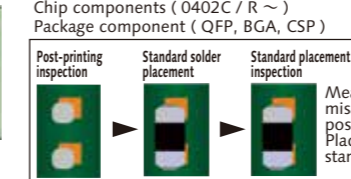

APC-MFB2 Feedforward to AOI / Feedback to the placement machine

Inspects part location based on APC offset correction position.

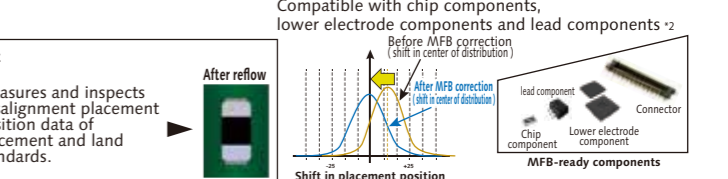

*1 : APC-FB (feedback) / FF (feedforward) : 3D inspection machine of another company can be also connected. (Please ask your local sales representative for details.)
 *2 : APC-MFB2 (mounter feedback2) : Applicable component types vary from one AOI vendor to another. (Please ask your local sales representative for details.)

Automatic recovery option

Pickup position automatic teach in case of an error

When pickup / recognition error occurred, the machine automatically corrects the pickup position without stopping, and resumes production. That improves machine operation rate.

(Components: 4 mm embossed (black) / 8 mm paper / embossed (black) tape component. *Embossed tape (transparency) is not supported.)

[Automatically resume production after pickup position teach]

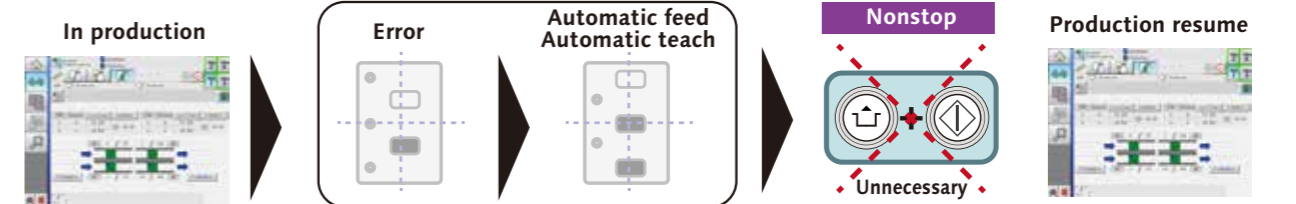

Re-pickup of error component (retry)

In case of a pickup error, retry pickup without feeding tape. It reduces discard components.

[In case of an error: re-pickup (retry) at the current position]

*No tape feed

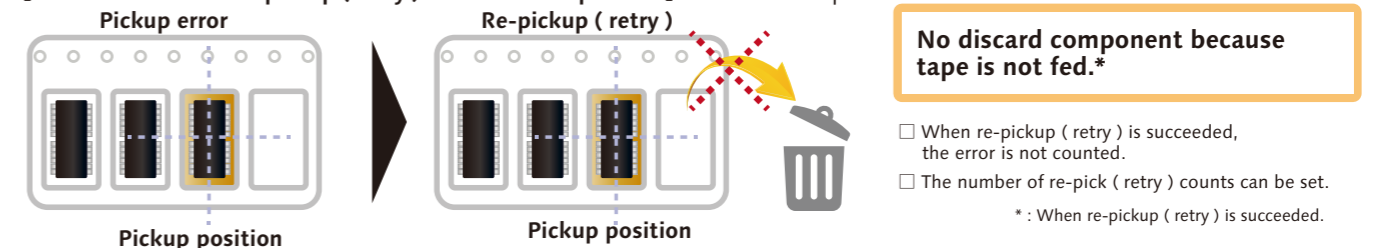

Automated constant check

LCR checker

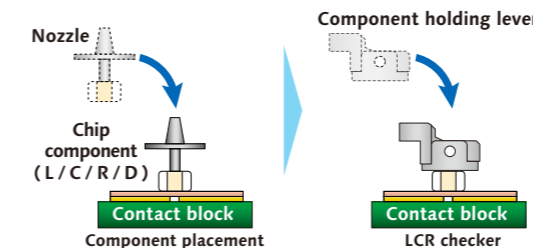

An LCR check is performed on mounted components at the start of production, or during component supply or product changeover. It helps detect wrong reels loaded and defective components. In addition, because verified data is output to a file on LNB (FA PC), the data can also be used for trace management.

Component size	0402 to 6 mm
Component	Resistance, Capacitor, Inductor, Diode

3 Minimization of human-dependent work

Remote operation option

Recovery by remote operation is available for the error of which recovery can be made based on human judgment alone. This enables concentrated on-the-floor monitoring, eliminating the time lost for the operator to detect error and take appropriate action, reducing the error recovery time, and thus achieving labor saving and improved operating rate.

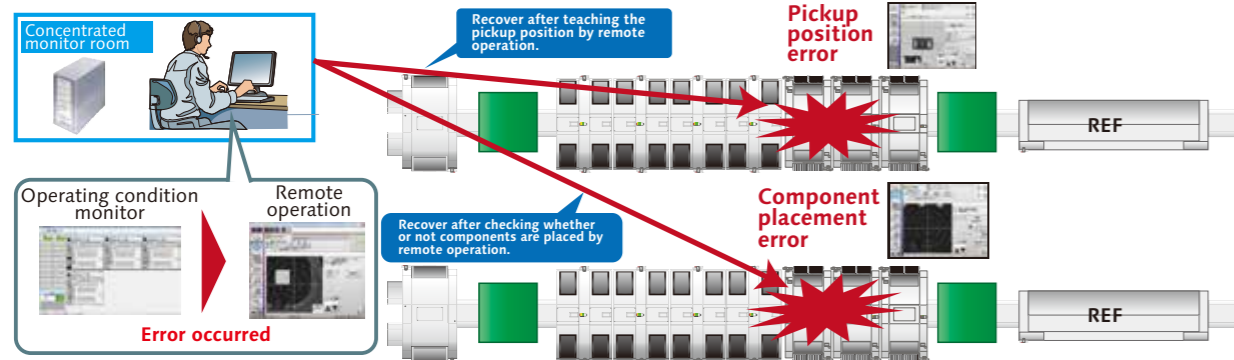

AOI Info Display option

Information on components judged NG by AOI is displayed both on AOI and NPM.

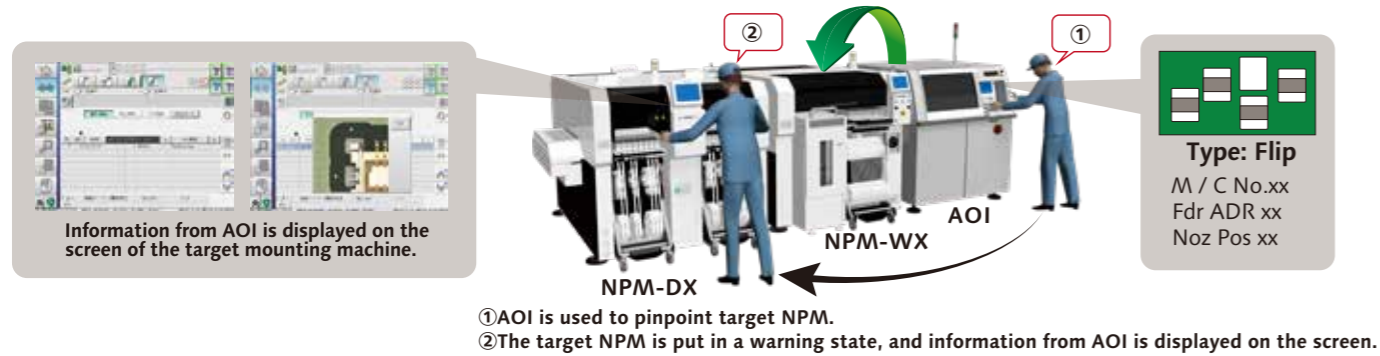

Feeder setup navigator option

It is a support tool to navigate efficient setup procedure. The tool factors in the amount of time it takes to perform and complete setup operations when estimating the time required for production and providing the operator with setup instructions. This will visualize and streamline setup operations during setup for a production line.

Parts supply navigator option

It is a parts supply support tool to present an efficient sequence of parts supply. Taking into account the length of time before parts shortage occurs and the least time-wasting moving path possible, the tool provides the operator with instructions for parts supply. This makes parts supply more efficient.

Placement head maintenance

Good use is made of the machine's self-diagnosis function to automatically detect the maintenance timing of the placement head. In addition, the maintenance unit can be used to keep the placement head in working condition without requiring skills.

Feeder maintenance

Independent of operator skill, the feeder maintenance unit automatically performs feeder performance inspections and calibrations. Its combined use with the PanaCIM maintenance module can automatically prevent the inclusion of non-conforming feeders into production.

Load checker V2

Measures the "indentation load" imposed by placement head and has the machine and LNB displayed the measurement result (possible to measure even a low load of 0.5 N as well).

Head maintenance unit

To automate the inspection and maintenance of the placement head.

Feeder maintenance unit

It automates an inspection of major parts affecting the feeder's performance and calibrates the pickup position to prevent short-time stoppages and maintain quality. For FMU (exclusive to ASF¹), the judgment accuracy has been improved and the X-directional adjustability has been automated.

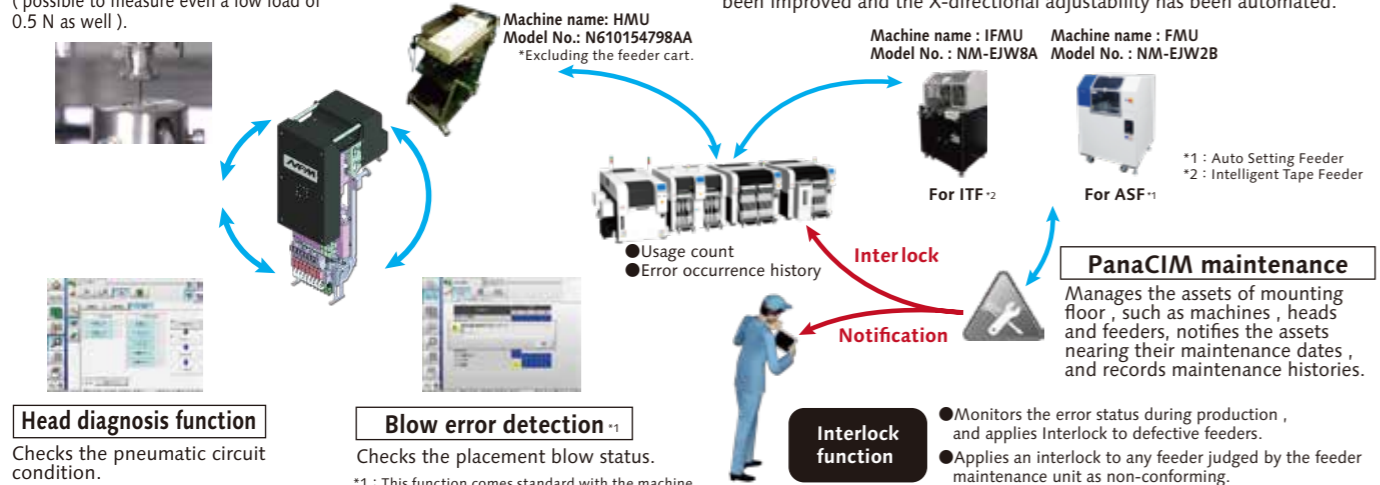

Data Creation System

NPM-DGS (Model No. NM-EJS9A)

This is a software package that provides integrated management of component library and PCB data, as well as production data that maximizes mounting lines with high-performance and optimization algorithms.

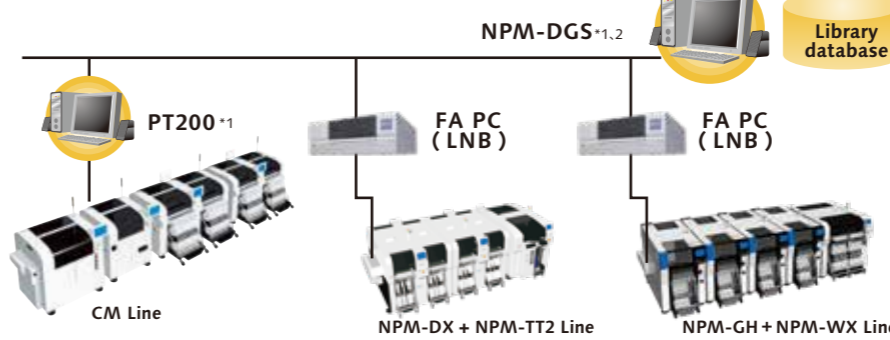

*1: A computer must be purchased separately.
*2: NPM-DGS has two management functions of floor and line level.

CAD import

Allows you to import CAD data and check polarity, etc., on the screen.

Optimization

Realizes high productivity and also allows you to create common arrays.

PPD editor

Update production data on PC during production to reduce the loss of time.

Component library

Allows unified management of the component library including mounting, inspection and dispensing.

Offline Camera unit V2

New component data can be created offline without relying on an individual operator's skill and proficiency, thus contributing to quality improvement and O.E.E maximization.

Thanks to adoption of a new component recognition camera and a wider variety of dedicated software functions, it now enables you to create component data more efficiently.



Offline Camera unit V2

DGS Automation option

Automated manual routine tasks reduce operation errors and data creation time. Manual routine tasks can be automated. By collaborating with the customer system, the routine tasks for creating data can be reduced, so it contributes to a significant reduction in production preparation time. It also includes the function to automatically correct the coordinates and angle of the mounting point (Virtual AOI).

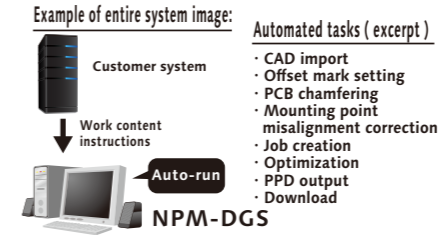

Optimization of setup option

In production involving multiple models, setup workloads are taken into account and optimized. For more than one PCB sharing common component placement, multiple setups may be required due to a shortage of supply units. In order to reduce the required setup workloads in such a case, this option divides PCBs into similar component placement groups, selects a table (s) for setup and thus automates component placement operation. It contributes to improving setup performance and reducing production preparation time for customer manufacturing various kinds of products in small quantities.

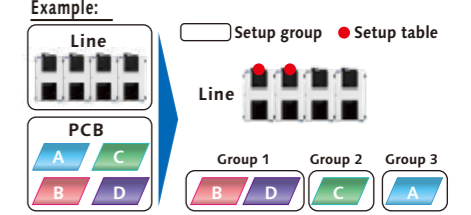

Changeover ability

All machines, including NPM, in SMT line are connected via iLNB, which allows automatic changeovers to be performed sequentially, starting from the first machine in the line.

● Trigger for changeover
You can select from among the following three methods: PCB ID reading using an external scanner, Production plan, and Report / Kanban reading.

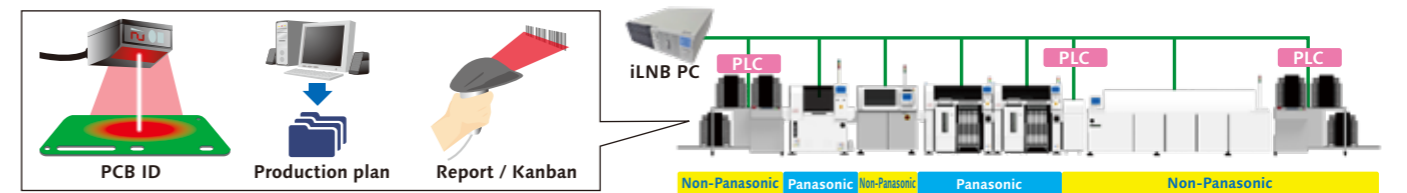

Open interface

Able to standardize the interfacing with your systems currently used. Provides data communication with our standard interfaces.



Host communication option

- **Events**
Outputs a real-time event of equipment.
- **Other company's component verification**
Communicates with your component verification systems.
- **Component management data**
 - Component remaining quantity data: Outputs component remaining quantity data.
 - Trace data: Outputs data linked with component information* and PCB information.

*Entry of component information with PanaCIM material verification or other company's component verification (this option) is required.