



FEINMETALL

Contact Technologies



FINE PITCH & INTERFACE SOLUTIONS

Pushing the edge of what is possible

> [FEINMETALL.COM](https://www.feinmetall.com)



ULTIMATE RELIABILITY
& PRECISION

CONTENT

GENERAL INFORMATION	4
FINE PITCH PROBES	16
FINE PITCH PROBES - Pitch 0.11 - 0.29 mm	18
FINE PITCH PROBES - Pitch 0.30 - 0.50 mm	20
FINE PITCH PROBES - Pitch > 0.50 mm	38
INTERFACE SOLUTIONS	54
WLCSP SOLUTIONS X FEINPROBE®	56



PASSION FOR FINEST TECHNOLOGY

Competence

FEINMETALL is your partner for the reliable contacting of electronic components. The wide range of applications for spring contact probes includes board tests with small pitches up to wire harness and connector tests with individual and intelligent solutions.

Innovative capacity

Since more than 60 years FEINMETALL represents a high level of innovation. Many patent-registered solutions have been milestones in the world of test engineering.

Broad competence in-house

The development and manufacturing of spring contact probes, special contact solutions and Semiconductor Test products in one company are a wide basis for our competence in precision technology and micro-mechanics. This combination is unique at the market and represents "German Technology" at its best.

International customer service

We are acting in the international hightech industry and our processes are aligned accordingly. With nine subsidiaries worldwide and a strong network of well trained partners we are always connected to the markets and to our customers, wherever they are. Local stocks and special customs certificates provide a high delivery performance. (e.g. AEO - Authorised Economic Operator).

Quality

Quality controls all process steps at FEINMETALL. From product development and construction up to manufacturing and delivery all operation steps are perfectly aligned.

FEINMETALL is certified according to DIN ISO 9001. Additionally a wide range of measures like e.g. risk analysis by FMEA during the whole product development process ensure a maximum of technical as well as delivery reliability.

Environment and health protection

FEINMETALL is committed to the goals of the up-to-date legislation regarding environment as well as health protection and to conformance to all necessary measures. The current statements regarding the various European environment and health regulations are available on our homepage.

Customer focus

Our engineers and technicians work closely together with our customers and have a deep knowledge of the practical applications. Our know-how is your advantage!

FM Choice

What is FM Choice?

FM Choice is our specially curated selection of the most reliable and frequently used probes in the market. Based on our expertise and experience, we have pre-selected the top-performing probes, so you don't have to choose from hundreds of options. With FM Choice, we make your decision easier by offering the most trusted solutions that meet your needs.

One of the greatest advantages of FM Choice is high availability and fast delivery, as we can often ship directly from our stock. This enables us to meet your demands whenever you need them. Plus, FM Choice offers competitive pricing, even for smaller quantities, making it an attractive solution for all kinds of projects.

Our portfolio includes over 700 contact probes for pitches between 4 and 100 mil, covering a wide range of applications and ensuring we meet most technical requirements quickly and efficiently.

Benefits at a glance



Most trusted solutions



Competitive prices



Fast delivery & high availability

Discover FM Choice products online

With our new Product Finder, we offer you a complete overview of all FM Choice products that you can easily search through. This high-performance tool allows you to search for specific products and compare them based on their technical features.

In addition to the FM Choice products, we invite you to explore the other categories to discover our complete product portfolio. Start your selection now and experience the variety and quality of our products.



> FEINMETALL.COM/PRODUCT-FINDER

OVERVIEW OF TIP STYLES



Spade versions



TYPICAL TIP STYLES AND APPLICATIONS



Conical (01,02,03,10,18,32,34,35)

Universal tip style with different angles of 10°, 15°, 30°, 60°, 90° or 120° for contacting solder pads and vias.



Spherical (11,12)

For testing clean contact surfaces, does not leave marks or scratches.



Flat (16,17)

Suitable for solder pads and contact pins.



Crown (09,35,40,41,42,60,63)

For wire wrap posts, even if the contacts are bent or twisted.

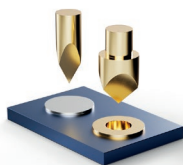

Triangular stepped (15,30,62)

For via holes and solder pads. The sharp edges penetrate flux residues and oxide layers.



Spade non centric for fine pitch kelvin test (71,72)

The probes can be used in the smallest pitches for Kelvin measurement. With a corresponding hole pattern in the drill plate, this type of mounting also provides an anti-rotation feature.

HIGH QUALITY SOLUTIONS DOWN TO
A PITCH OF 110 μ m

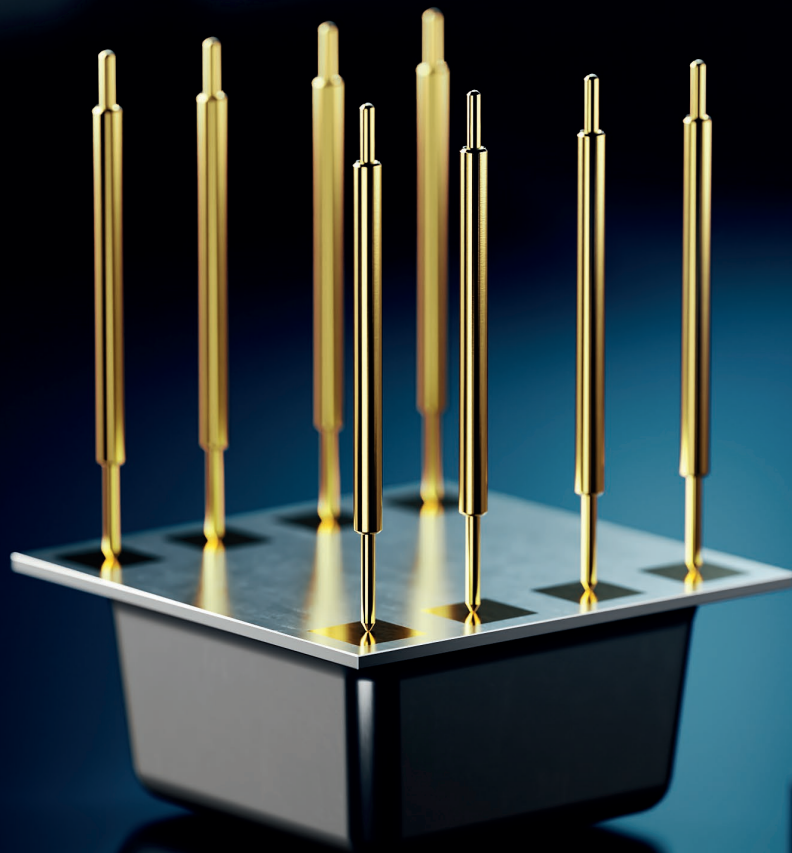

APPLICATIONS

When it comes to the contacting of test points in very small dimensions, Fine Pitch Probes are needed. Fine Pitch Probes are essential parts in the electronics industry, ensuring accurate and reliable testing and measurement of electronic components and circuits. These probes are mainly used in applications like Semiconductor Final Testing, WLCSP solutions, MEMS sensor tests or the testing of micro PCBs. Due to the small pitches in these

applications, a deep expertise and precision in production is required, to guarantee the best possible contacting. FEINMETALL offers highly precise engineered Fine Pitch Probes that ensure a high lifetime, excellent quality and repeatability with the goal to advance the customers yield. We are able to offer Fine Pitch Probes down to a pitch of 110µm to provide the solution of your needs.

Semiconductor Final Testing

Through rigorous final testing, manufacturers can guarantee that only high quality and fully functional semiconductors reach the market, ensuring the reliability of electronic devices for end-users. To realize these tests, Fine Pitch Probes are necessary. FEINMETALL Fine Pitch Probes are able to contact different package types of these chips such as BGA, QFN, LGA ,QFP etc. with a high quality and repeatability. In our diverse portfolio you will find a suitable probe for all of your applications.



MEMS Sensor Testing

Testing MEMS sensors means checking if they work well and are accurate. Fine Pitch Probes allow engineers to access specific points on the sensor, enabling full testing and analysis.

The high level of precision provided by FEINMETALL Fine Pitch Probes is essential for evaluating the performance parameters of MEMS sensors. We provide a wide range of options of these probes with excellent quality standards to secure your best testing results.



Micro PCB Testing

Testing micro PCBs is essential for ensuring the functionality of compact electronic devices like smartphones and wearables. PCB Testing means making safe electrical connections with these tiny boards. These processes guarantee the reliability and functionality of modern electronic gadgets. FEINMETALL Fine Pitch Probes are designed by our engineers, to provide you the best possible solution with a long lifetime.



MAIN APPLICATION OF FINE PITCH PROBES

Functional structure and application of Fine Pitch Probes

Fine Pitch Probes are extremely thin contact probes for the use in pitches of 0.11 mm to 1.0 mm. In most cases Fine Pitch Probes are not mounted in separate receptacles, but they are mounted in sandwich design blocks connecting a DUT with a PCB. Typical applications are contacting PCBs with very small structures and building up test sockets. In these

pitches direct soldering of probes as well as using receptacles with larger diameters is not possible any more. Therefore, most Fine Pitch Probes are used in floating movement that connect a DUT to a printed circuit board.

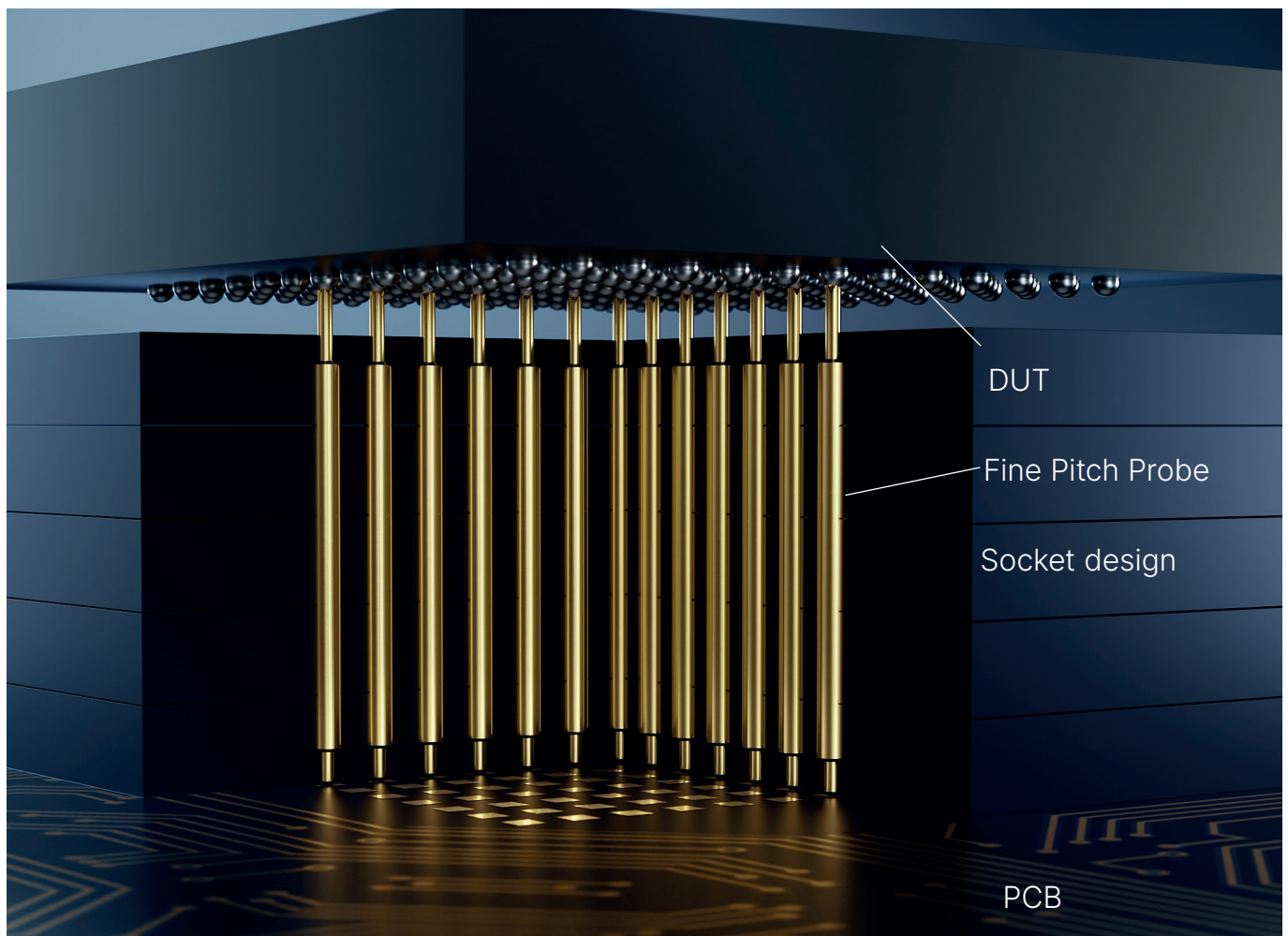

RF DIAGRAM IN GENERAL

Comments on RF properties

The high-frequency properties of the contact probes are determined using 3D fem simulation in a GND-SGN-GND arrangement, in the respective pitch and at nominal stroke. For the purpose of standardization, assumptions are made that may deviate from real operating conditions. A test socket made of PEEK (see Fig. Socket design) is assumed as standard. In addition, S-parameters are shown for a typical FEINMETALL test head (FeinProbe® see Fig. Probe Card Head). Due to its patented

design and materials, this probe almost always provides better RF performance than the socket design. With additional optimization, using special FEINMETALL RF designs, test cards can be adapted very well to individual requirements. FEINMETALL has the know-how and technologies to design and manufacture the optimum test product for high frequency applications up to 100 GHz.

Radio frequency performance [GHz]

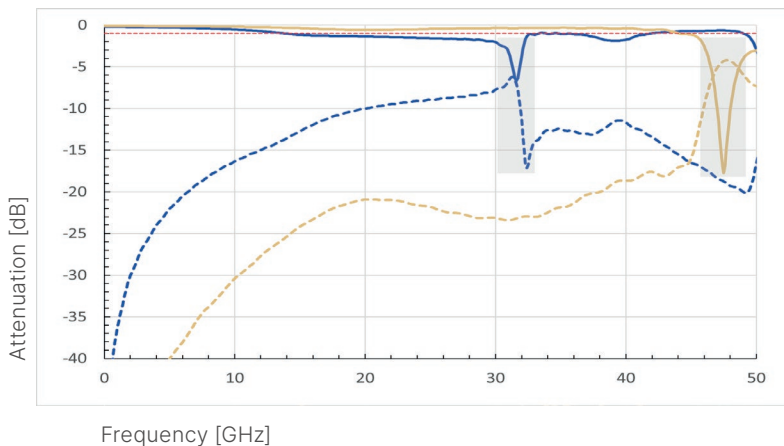

Caption legend:

- - - Limit -1dB
- Socket S21 (Insertion loss1)
- - - Socket S11 (Return loss1)
- Probe Card Head S21 (Insertion loss2)
- - - Probe Card Head S11 (Return loss2)

Notes on presentation

Such pronounced peaks and jumps in the S-parameters originate from simulation artefacts that arise due to ideally plane-parallel, smooth reflection surfaces in the model. In practice, these will not occur or will be very attenuated.

Socket design

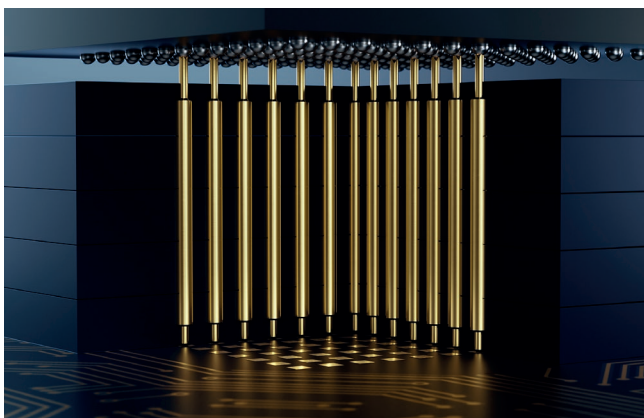

Probe Card Head

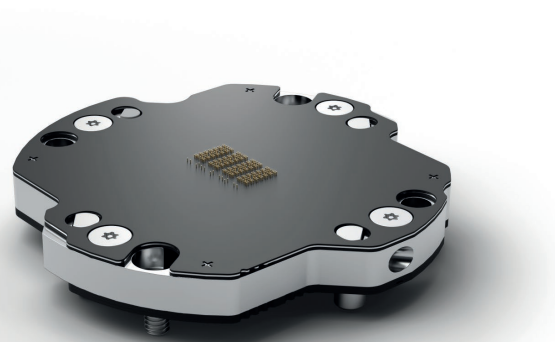

FINE PITCH PROBES AT A GLANCE

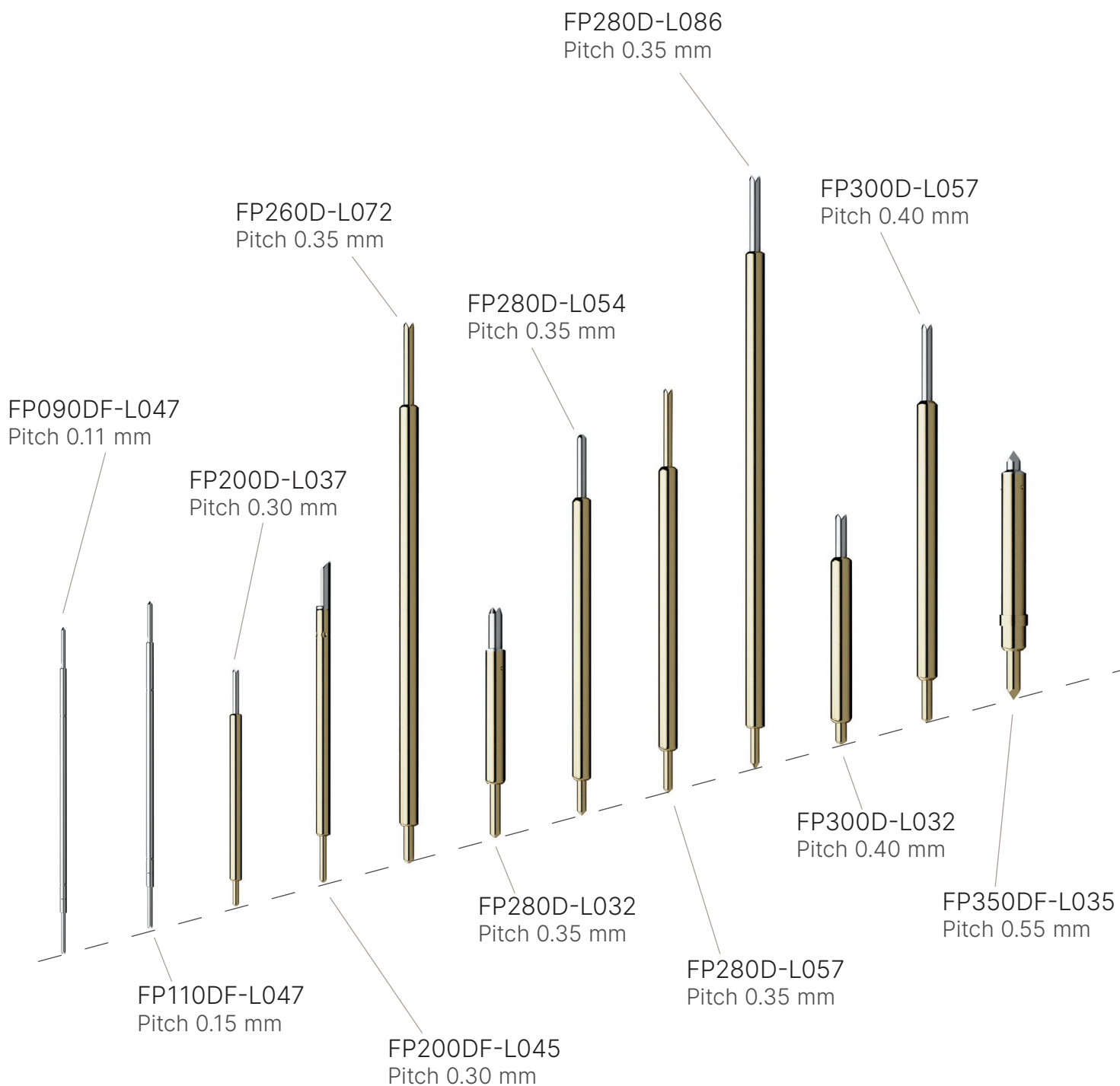

GENERAL INFORMATION

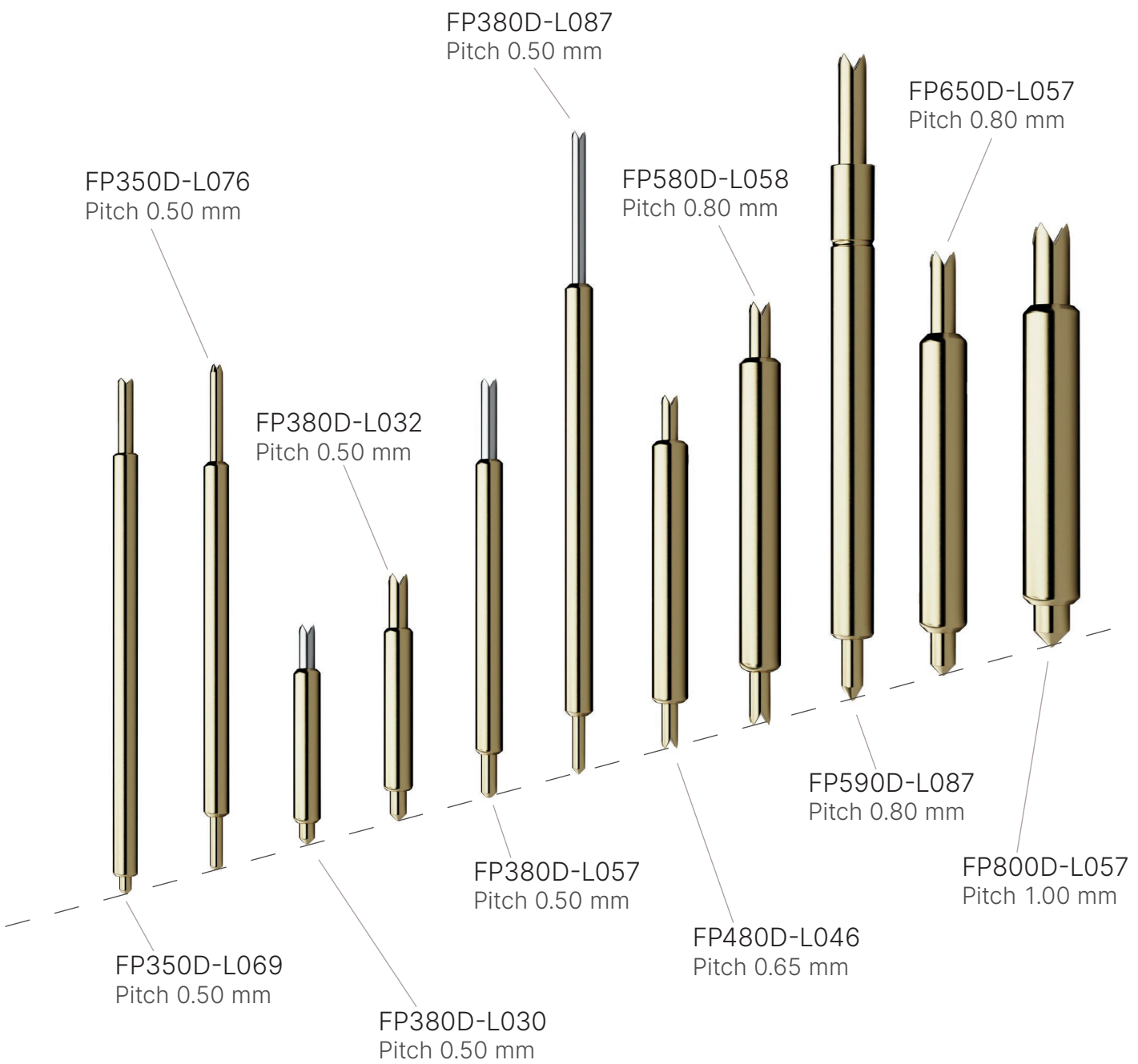

SECURE SIGNAL TRANSMISSION
UP TO 60 GHz



PRODUCT NAME

Number code system

In order to improve the clarity of the material designations, the self-explanatory number code has been further developed. Therefore, all fine pitch probes have been redefined according to the order code shown below.

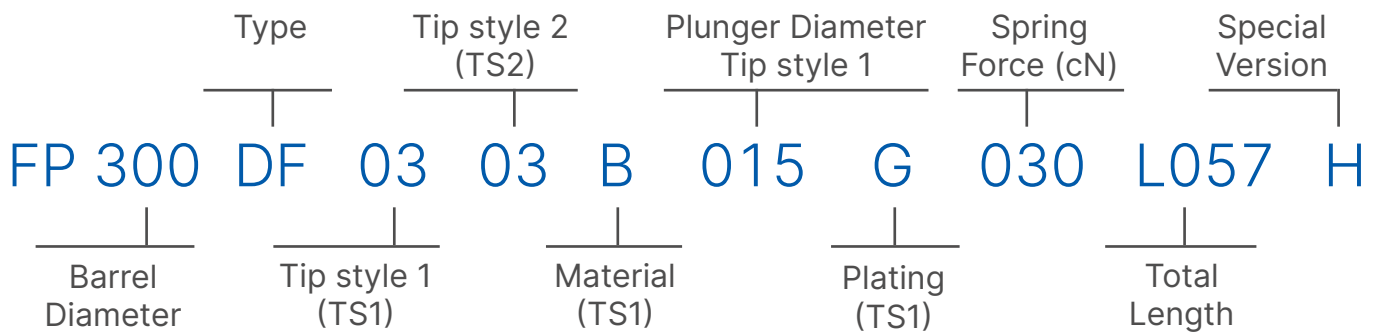

Type

- S = Single Plunger single acting
- D = Double Plunger double acting
- DF = Double Plunger single acting

Material Plunger

- B = BeCu (Beryllium Copper)
- P = Palladium alloy
- S = Steel

Plating Plunger

- G = Gold plate
- P = Palladium alloy
- S = Silver plated
- U = Unplated

Special Version

- H = High temperature version
- B = Banana version
- NM = Non magnetic version

Type Description

To simplify matters in many contexts, only the product type designation is given rather than the complete individual article number. This consists of the barrel diameter, the function type, the total length and, if applicable, a special function.

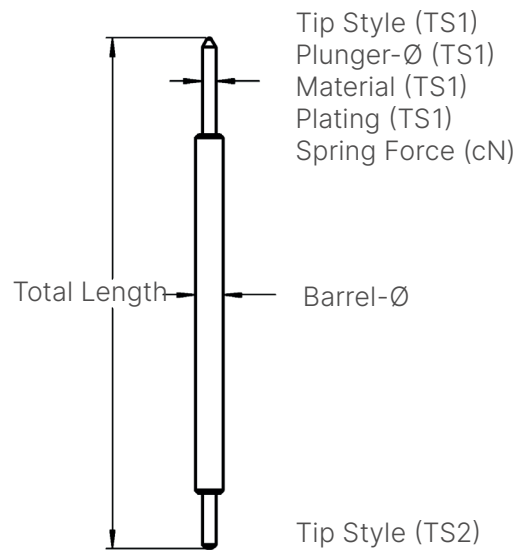

The material and plating of „Tip Style TS2“ is standard and always the same for all versions within a probe series.

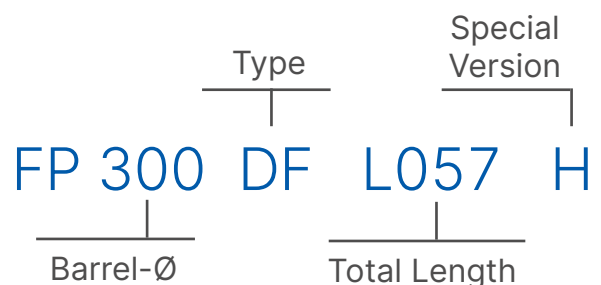

FINE PITCH PROBES - PITCH 0.11 - 0.29 MM

FM Choice

FP090DF-L047

0.11 mm Pitch | Single acting



Electrical specifications

Current [A]	0.25	
R _{TYP} [mOhm]	<600	
Self Inductance [nH]	1.89	
Frequency at -1dB [GHz]	Socket [Pitch 0.15]	Probe Card [Pitch 0.11]
	33	43

Mechanical specifications

Temperature [°C]	-45°...+120°	
Preload [cN]	0.8	
Spring force at nt [cN ±20%]	4.5	
Nominal travel [mm]	0.40	
Maximum travel [mm]	0.50	

Materials and plating

Top Plunger	Palladium alloy	unplated
Bottom Plunger (rigid)	Palladium alloy	unplated
Barrel	Nickel	gold plated (inside)
Spring	Spring steel	gold plated

Drill size recommendation [mm]

Equal barrel diameter	0.10 - 0.12
-----------------------	-------------

Series drawing

All measurements are in mm.

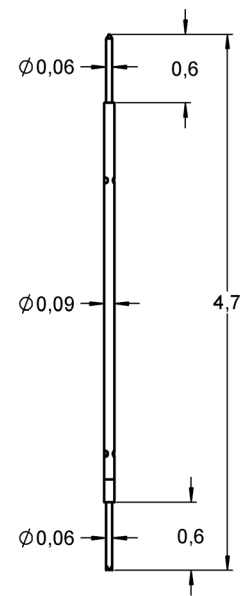

Radio frequency performance [GHz]

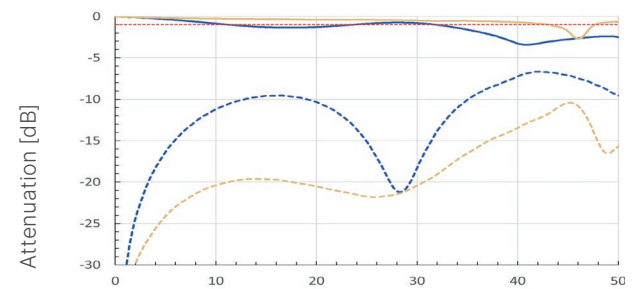

Frequency [GHz]

Caption legend p.11

Order code	Product name	Top plunger	Bottom plunger	Ø in mm	FM Choice
1135965	FP090DF0329P006U005L047	03	29	0.06	

FINE PITCH PROBES - PITCH 0.11 - 0.29 MM

FM Choice

FP110DF-L047

0.15 mm Pitch | Single acting



Electrical specifications

Current [A]	0.25	
R _{TYP} [mOhm]	<500	
Self Inductance [nH]	1.72	
	Socket [Pitch 0.15]	Probe Card [Pitch 0.17]
Frequency at -1dB [GHz]	33	42

Mechanical specifications

Temperature [°C]	-45°...+120°	
Preload [cN]	1.7	
Spring force at nt [cN ±20%]	6.0	
Nominal travel [mm]	0.40	
Maximum travel [mm]	0.50	

Materials and plating

Top Plunger	Palladium alloy	unplated
Bottom Plunger (rigid)	Palladium alloy	unplated
Barrel	Nickel	gold plated (inside)
Spring	Spring steel	gold plated

Drill size recommendation [mm]

Equal barrel diameter	0.12 - 0.14
-----------------------	-------------

Series drawing

All measurements are in mm.

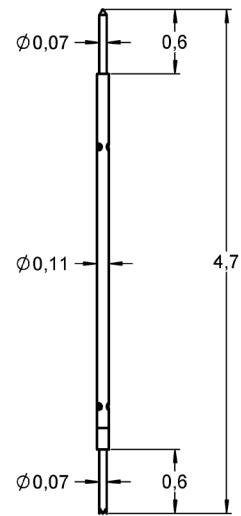

Radio frequency performance [GHz]

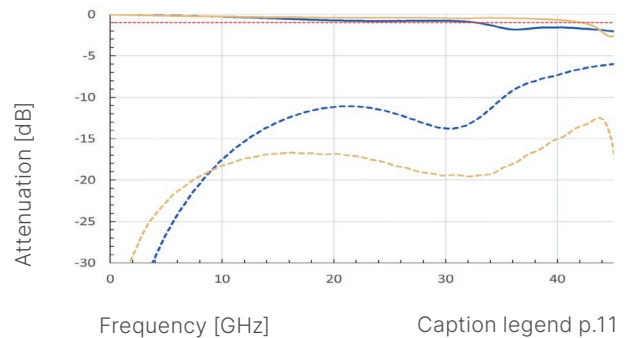

Order code	Product name	Top plunger	Bottom plunger	Ø in mm	FM Choice
1040994	FP110DF0329P007U006L047	03	29	0.07	

TESTING THE SMALLEST PCBs

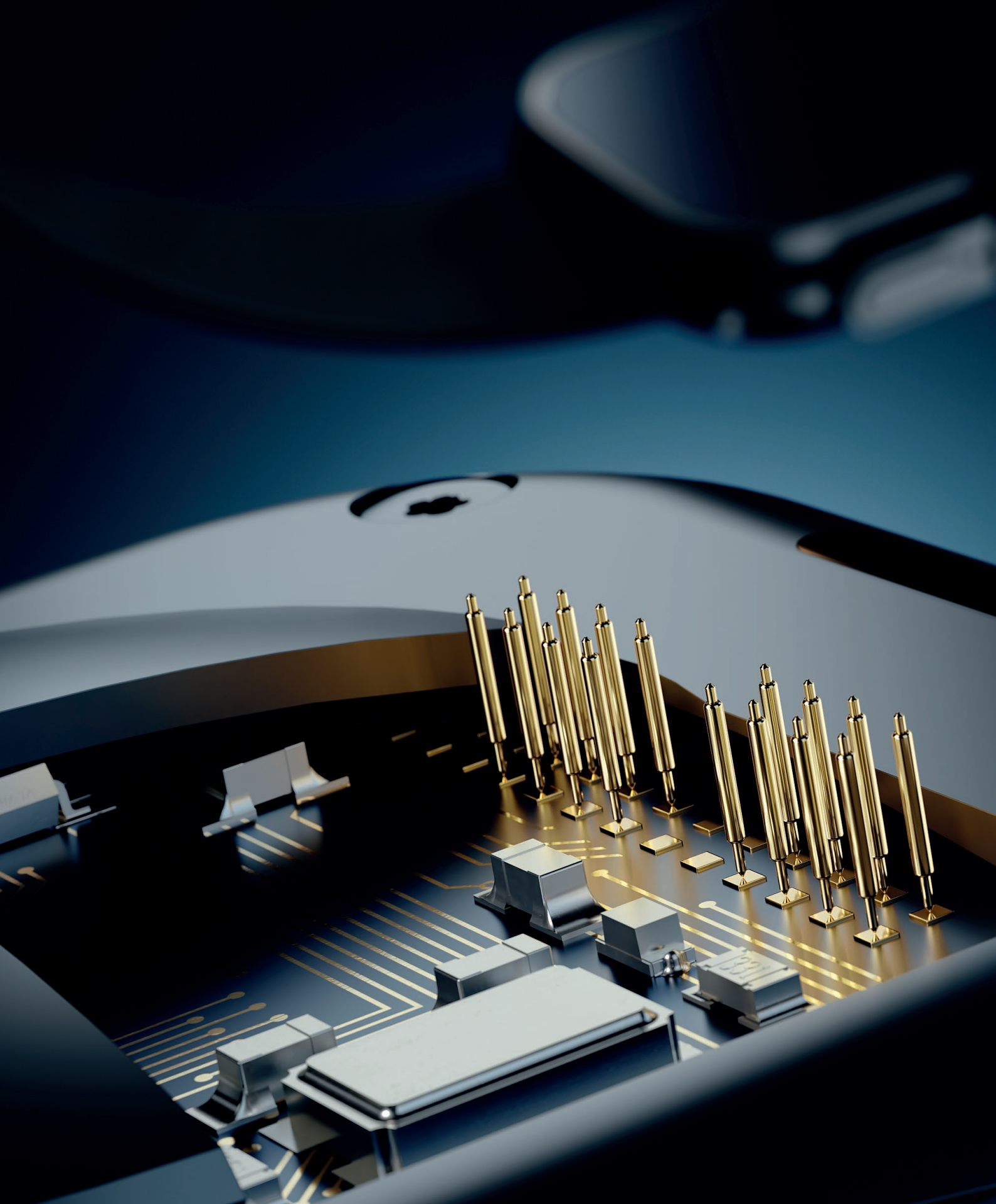

FINE PITCH PROBES - PITCH 0.30 - 0.50 MM

FM Choice

FP200D-L037

0.30 mm Pitch | Double acting



Electrical specifications

Current [A]	0.8	
R _{TYP} [mOhm]	<100	
Self Inductance [nH]	1.27	
	Socket	Probe Card
Frequency at -1dB [GHz]	22	42.5

Mechanical specifications

Temperature [°C]	-45°...+120°	
Preload [cN]	7	5
Spring force at nt [cN ±20%]	17	13
Nominal travel [mm]	0.40	0.40
Maximum travel [mm]	0.50	0.50

Materials and plating

Top Plunger	BeCu	gold plated
	Palladium alloy	unplated
Bottom Plunger	BeCu	gold plated
Barrel	Nickel	gold plated
Spring	Spring steel	gold plated

Drill size recommendation [mm]

Equal barrel diameter	0.21 - 0.23
-----------------------	-------------

Series drawing

All measurements are in mm.

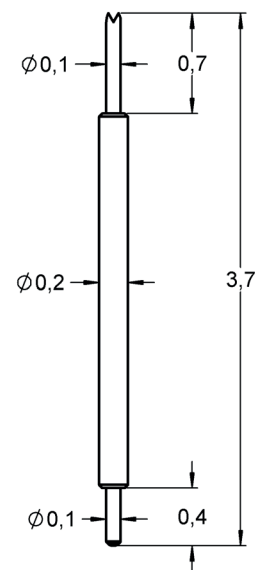

Radio frequency performance [GHz]

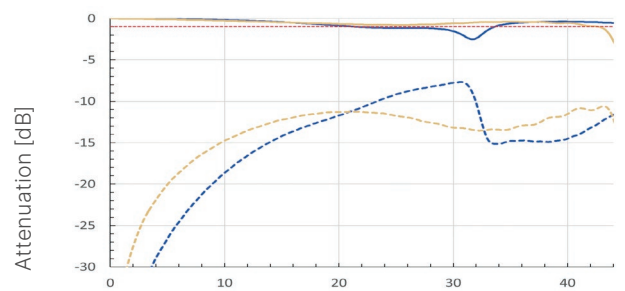

Frequency [GHz]

Caption legend p.11

Order code	Product name	Top plunger	Bottom plunger	Ø in mm	FM Choice
1023002	FP200D0301B010G017L037	03	01	0.10	FM Choice
1023129	FP200D2901B010G017L037	29	01	0.10	FM Choice
1030448	FP200D2901P010U013L037	29	01	0.10	FM Choice

FINE PITCH PROBES - PITCH 0.30 - 0.50 MM



FP200DF-L045

0.30 mm Pitch | Single acting

Electrical specifications

Current [A]	0.7	
R _{TYP} [mOhm]	<500	
Self Inductance [nH]	1.62	
	Socket	Probe Card
Frequency at -1dB [GHz]	27..5	38.5

Mechanical specifications

Temperature [°C]	-45°...+120°	
Preload [cN]	10	
Spring force at nt [cN ±20%]	15	
Nominal travel [mm]	0.30	
Maximum travel [mm]	0.45	

Materials and plating

Top Plunger	BeCu	gold plated (rigid)
	Palladium alloy	unplated
Bottom Plunger	BeCu	gold plated
Barrel	Nickel	gold plated (inside)
Spring	Spring steel	gold plated

Drill size recommendation [mm]

Equal barrel diameter	0.21 - 0.23
-----------------------	-------------

Series drawing

All measurements are in mm.

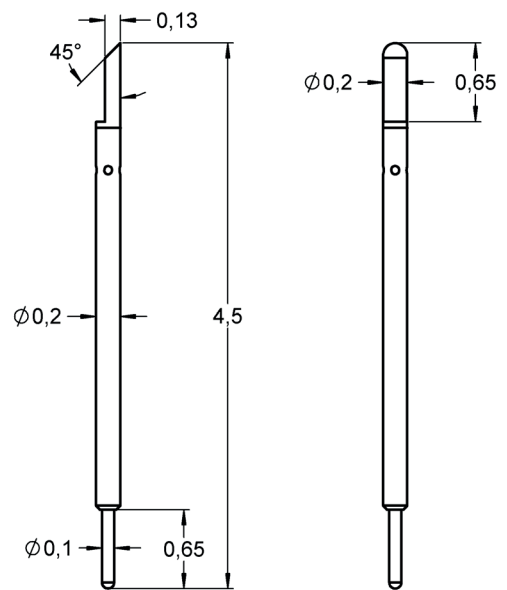

Radio frequency performance [GHz]

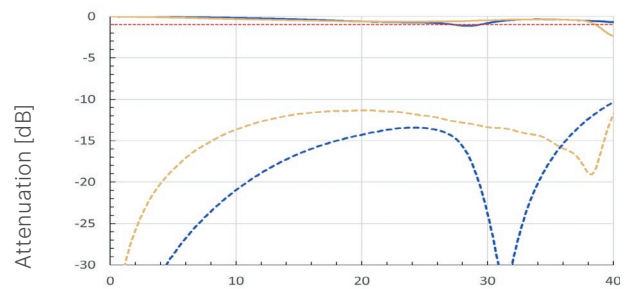

Frequency [GHz]

Caption legend p.11

Order code	Product name	Top plunger	Bottom plunger	Ø in mm	FM Choice
1024610	FP200DF7111B020G015L045	71	11	0.13	-
1030202	FP200DF7111P020U015L045	71	11	0.13	-

FINE PITCH PROBES - PITCH 0.30 - 0.50 MM



FP210D-L057

0.30 mm Pitch | Double acting

Electrical specifications

Current [A]	0.5	
R _{TYP} [mOhm]	<150	
Self Inductance [nH]	1.86	
	Socket	Probe Card
Frequency at -1dB [GHz]	14	29

Mechanical specifications

Temperature [°C]	-45°...+120°	
Preload [cN]	3.5	3
Spring force at nt [cN ±20%]	11	16
Nominal travel [mm]	0.60	0.50
Maximum travel [mm]	1.00	0.60

Materials and plating

Top Plunger	BeCu	gold plated
Bottom Plunger	BeCu	gold plated
Barrel	Nickel	gold plated
Spring	Spring steel	gold plated

Drill size recommendation [mm]

Equal barrel diameter	0.22 - 0.24
-----------------------	-------------

Series drawing

All measurements are in mm.

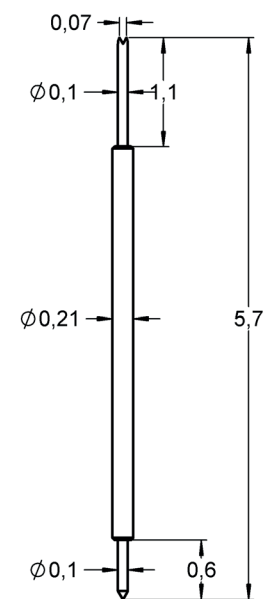

Radio frequency performance [GHz]

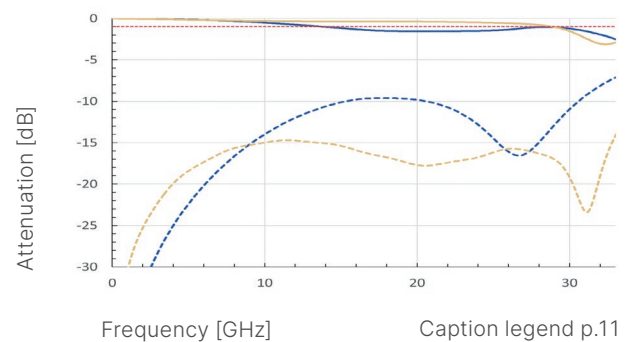

Order code	Product name	Top plunger	Bottom plunger	Ø in mm	FM Choice
1031798	FP210D0303B010G016L057	03	03	0.10	-
1024774	FP210D2903B010G011L057	29	03	0.10	-

FINE PITCH PROBES - PITCH 0.30 - 0.50 MM

FM Choice

FP260D-L072

0.35 mm Pitch | Double acting | High temperature version



Electrical specifications

Current [A]	1.5	
R _{TYP} [mOhm]	<100	
Self Inductance [nH]	2.07	
	Socket	Probe Card
Frequency at -1dB [GHz]	22.5	27.5

Mechanical specifications

Temperature [°C]	-45°...+150°	
Preload [cN]	7	
Spring force at nt [cN ±20%]	25	
Nominal travel [mm]	0.80	
Maximum travel [mm]	1.00	

Materials and plating

Top Plunger	BeCu	gold plated
Bottom Plunger	BeCu	gold plated
Barrel	Nickel	gold plated
Spring	Stainless steel	gold plated

Drill size recommendation [mm]

Equal barrel diameter	0.27 - 0.30
-----------------------	-------------

Series drawing

All measurements are in mm.

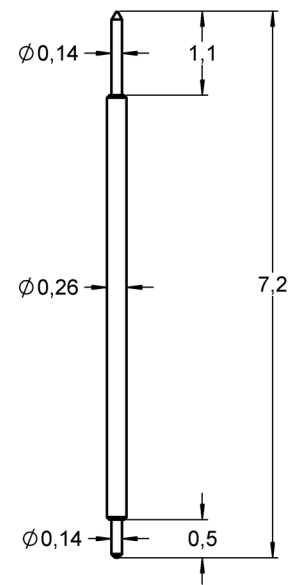

Radio frequency performance [GHz]

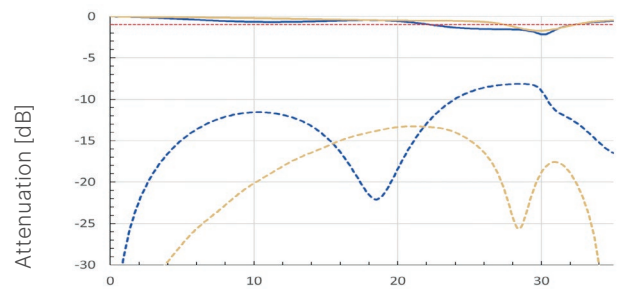

Frequency [GHz]

Caption legend p.11

Order code	Product name	Top plunger	Bottom plunger	Ø in mm	FM Choice
1023003	FP260D0301B014G025L072	03	01	0.14	
1023128	FP260D2901B014G025L072	29	01	0.14	

FINE PITCH PROBES - PITCH 0.30 - 0.50 MM

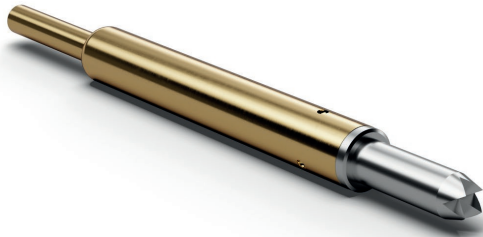

FP280DF-L033

0.35 mm Pitch | Double acting | High temperature version

Electrical specifications

Current [A]	2.5
R _{TYP} [mOhm]	-
Self Inductance [nH]	0.82

Mechanical specifications

Temperature [°C]	-45°...+150°
Preload [cN]	2.5
Spring force at nt [cN ±20%]	10
Nominal travel [mm]	0.30
Maximum travel [mm]	0.47

Materials and plating

Top Plunger (rigid)	Palladium alloy	unplated
Bottom Plunger	Palladium alloy	unplated
Barrel	Bronze	gold plated
Spring	Stainless steel	gold plated

Drill size recommendation [mm]

Equal barrel diameter	0.29 - 0.31
-----------------------	-------------

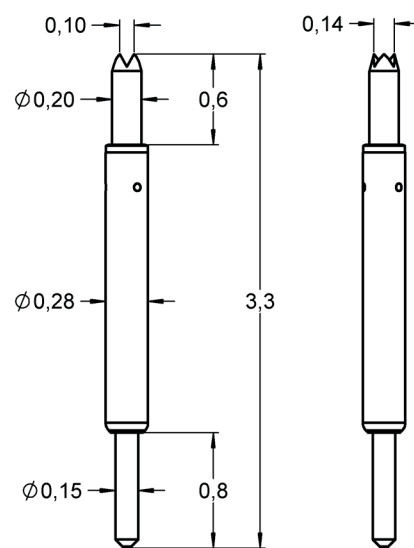

Series drawing

All measurements are in mm.

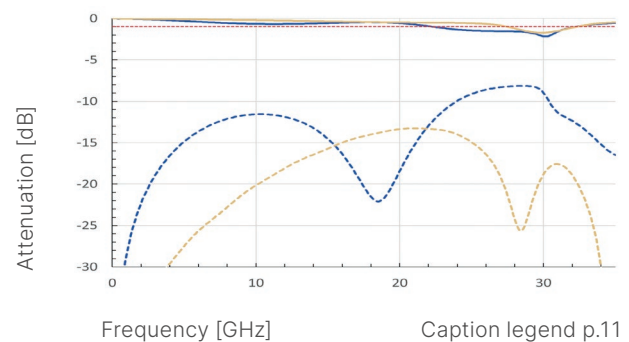

Radio frequency performance [GHz]



Order code	Product name	Top plunger	Bottom plunger	Ø in mm	FM Choice
1120799	FP280DF2911P020U010L033	29 	11 	0.20	-

FINE PITCH PROBES - PITCH 0.30 - 0.50 MM



FP280D-L054

0.35 mm Pitch | Double acting

Electrical specifications

Current [A]	1.5	
R _{TYP} [mOhm]	<125	
Self Inductance [nH]	1.36	
	Socket	Probe Card
Frequency at -1dB [GHz]	11	31.5

Mechanical specifications

Temperature [°C]	-45°...+120°	
Preload [cN]	6	
Spring force at nt [cN ±20%]	25	
Nominal travel [mm]	0.50	
Maximum travel [mm]	0.08	

Materials and plating

Top Plunger	Palladium alloy	unplated
Bottom Plunger	BeCu	gold plated
Barrel	Bronze	gold plated
Spring	Spring steel	gold plated

Drill size recommendation [mm]

Equal barrel diameter	0.29 - 0.31
-----------------------	-------------

Series drawing

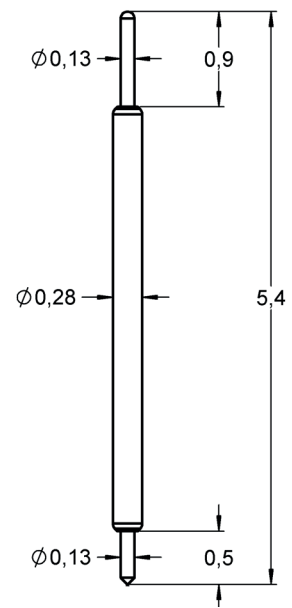

All measurements are in mm.

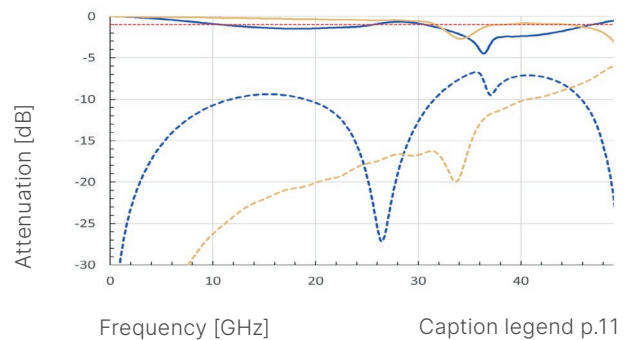

Radio frequency performance [GHz]



Caption legend p.11

Order code	Product name	Top plunger	Bottom plunger	Ø in mm	FM Choice
1087982	FP280D1101P013U025L054	11 	01 	0.13	-

FINE PITCH PROBES - PITCH 0.30 - 0.50 MM

FM Choice

FP280D-L057

0.35 mm Pitch | Double acting



Electrical specifications

Current [A]	1.5	
R _{TYP} [mOhm]	<100	
Self Inductance [nH]	1.44	
	Socket	Probe Card
Frequency at -1dB [GHz]	10	27.5

Mechanical specifications

Temperature [°C]	-45°...+120°	
Preload [cN]	6	6
Spring force at nt [cN ±20%]	25	30
Nominal travel [mm]	0.50	0.65
Maximum travel [mm]	0.80	1.10

Materials and plating

Top Plunger	BeCu	gold plated
	Palladium alloy	unplated
Bottom Plunger	BeCu	gold plated
Barrel	Bronze	gold plated
Spring	Spring steel	gold plated

Drill size recommendation [mm]

Equal barrel diameter	0.29 - 0.31
-----------------------	-------------

Series drawing

All measurements are in mm.

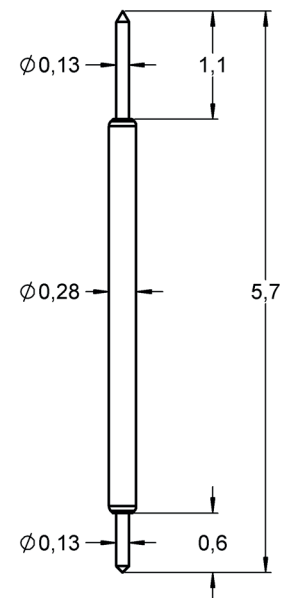

Radio frequency performance [GHz]

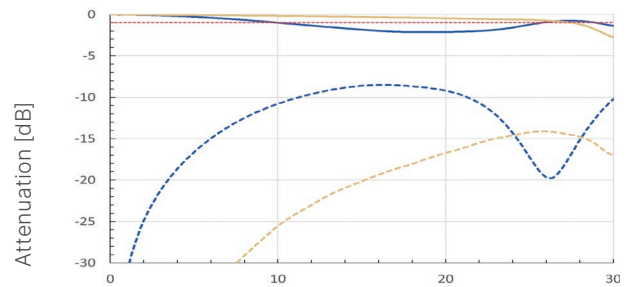

Frequency [GHz]

Caption legend p.11

Order code	Product name	Top plunger	Bottom plunger	Ø in mm	FM Choice
1031135	FP280D0301B013G025L057	03	01	0.13	FM Choice
1031133	FP280D2901B013G025L057	29	01	0.13	-
1030726	FP280D0301P013U030L057	03	01	0.13	-

FINE PITCH PROBES - PITCH 0.30 - 0.50 MM



FP280D-L057H

0.35 mm Pitch | Double acting | High temperature version

Electrical specifications

Current [A]	1.5
R _{TYP} [mOhm]	<125
Self Inductance [nH]	1.44
Frequency at -1dB [GHz]	11.5

Mechanical specifications

Temperature [°C]	-45°...+150°
Preload [cN]	6
Spring force at nt [cN ±20%]	15
Nominal travel [mm]	0.50
Maximum travel [mm]	0.80

Materials and plating

Top Plunger	BeCu	gold plated
	Palladium alloy	unplated
Bottom Plunger	BeCu	gold plated
Barrel	Bronze	gold plated
Spring	Stainless steel	gold plated

Drill size recommendation [mm]

Equal barrel diameter	0.29 - 0.31
-----------------------	-------------

Series drawing

All measurements are in mm.

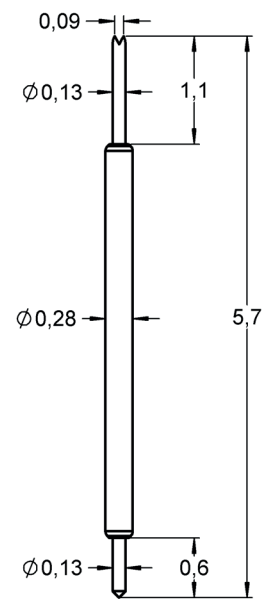

Radio frequency performance [GHz]

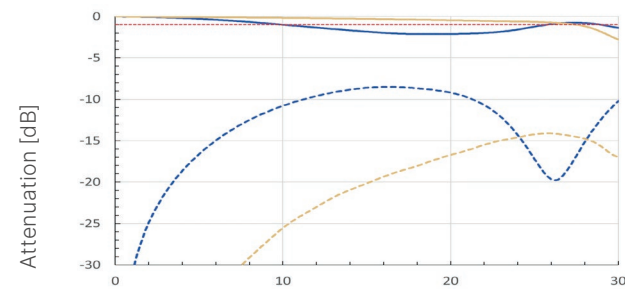

Frequency [GHz]

Caption legend p.11

Order code	Product name	Top plunger	Bottom plunger	Ø in mm	FM Choice
1035118	FP280D0101B013G015L057	01	01	0.13	-
1031136	FP280D0301B013G015L057	03	01	0.13	-
1031132	FP280D0301P013U015L057	03	01	0.13	-
1031134	FP280D2901B013G015L057	29	01	0.13	-

FINE PITCH PROBES - PITCH 0.30 - 0.50 MM



FP280D-L086

0.35 mm Pitch | Double acting | High temperature version

Electrical specifications

Current [A]	1.1	
R _{TYP} [mOhm]	<180	
Self Inductance [nH]	2.16	
	Socket	Probe Card
Frequency at -1dB [GHz]	19	26

Mechanical specifications

Temperature [°C]	-45°...+150°	
Preload [cN]	4	
Spring force at nt [cN ±20%]	20	
Nominal travel [mm]	0.80	
Maximum travel [mm]	1.10	

Materials and plating

Top Plunger	Palladium alloy	unplated
Bottom Plunger	BeCu	gold plated
Barrel	Nickel	gold plated (inside)
Spring	Spring steel	gold plated

Drill size recommendation [mm]

Equal barrel diameter	0.29 - 0.31
-----------------------	-------------

Series drawing

All measurements are in mm.

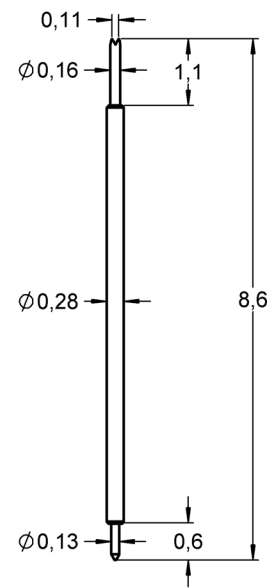

Radio frequency performance [GHz]

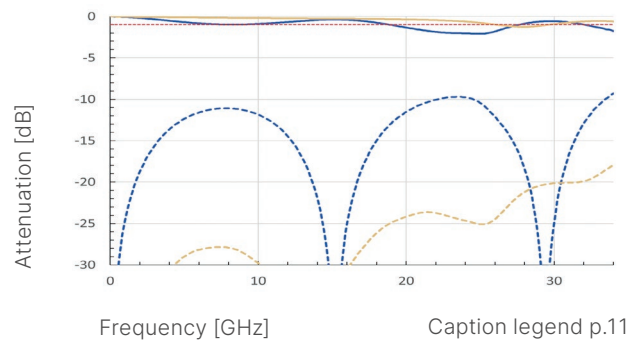

Order code	Product name	Top plunger	Bottom plunger	Ø in mm	FM Choice
1030449	FP280D2903P016U020L086	29	03	0.16	-

FINE PITCH PROBES - PITCH 0.30 - 0.50 MM

FM Choice

FP300D-L032

0.40 mm Pitch | Double acting



Electrical specifications

Current [A]	1.4	
R _{TYP} [mOhm]	<100	
Self Inductance [nH]	0.87	
	Socket	Probe Card
Frequency at -1dB [GHz]	19	48.5

Mechanical specifications

Temperature [°C]	-45°...+120°	
Preload [cN]	7	7
Spring force at nt [cN ±20%]	17	19
Nominal travel [mm]	0.45	0.45
Maximum travel [mm]	0.58	0.58

Materials and plating

Top Plunger	BeCu	gold plated
	Palladium alloy	unplated
Bottom Plunger	BeCu	gold plated
Barrel	Nickel	gold plated
Spring	Spring steel	gold plated

Drill size recommendation [mm]

Equal barrel diameter	0.31 - 0.33
-----------------------	-------------

Series drawing

All measurements are in mm.

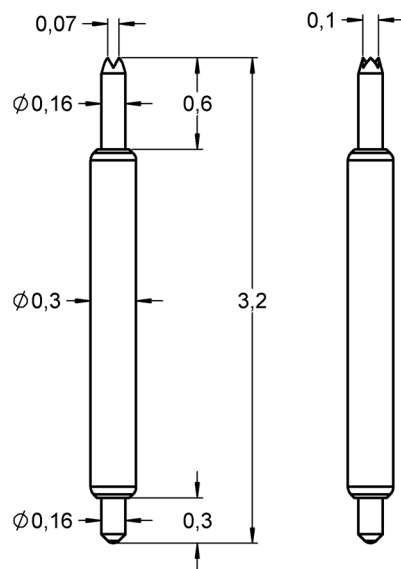

Radio frequency performance [GHz]

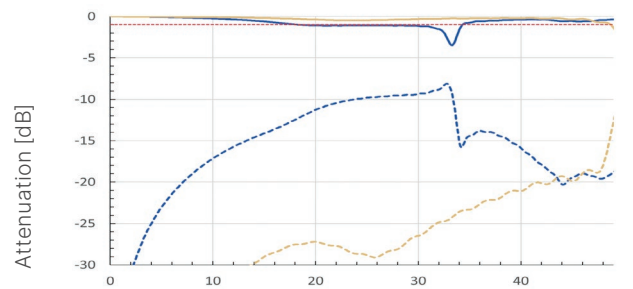

Frequency [GHz]

Caption legend p.11

Order code	Product name	Top plunger	Bottom plunger	Ø in mm	FM Choice
1023111	FP300D0301B016G019L032	03	01	0.16	FM Choice
1023004	FP300D2901B016G019L032	29	01	0.16	FM Choice
1024431	FP300D2901P016U017L032	29	01	0.16	-

FINE PITCH PROBES - PITCH 0.30 - 0.50 MM

FM Choice

FP300D-L057

0.40 mm Pitch | Double acting



Electrical specifications

Current [A]	1.4	
R _{TYP} [mOhm]	<100	
Self Inductance [nH]	1.61	
	Socket	Probe Card
Frequency at -1dB [GHz]	13	28.5

Mechanical specifications

Temperature [°C]	-45°...+120° -45°...+150° (H)	
Preload [cN]	3	5
Spring force at nt [cN ±20%]	25	30
Nominal travel [mm]	0.65	0.65
Maximum travel [mm]	0.80	0.80

Materials and plating

Top Plunger	BeCu	gold plated
	Palladium alloy	unplated
Bottom Plunger	BeCu	gold plated
Barrel	Nickel	gold plated
Spring	Spring steel	gold plated

Drill size recommendation [mm]

Equal barrel diameter	0.31 - 0.33
-----------------------	-------------

Series drawing

All measurements are in mm.

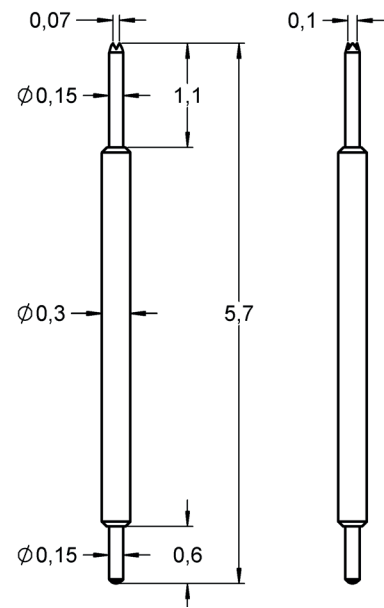

Radio frequency performance [GHz]

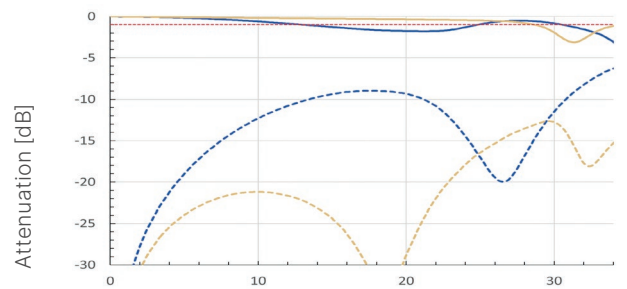

Frequency [GHz]

Caption legend p.11

Order code	Product name	Top plunger	Bottom plunger	Ø in mm	FM Choice
1023125	FP300D0301B015G030L057	03	01	0.15	FM Choice
1023005	FP300D2901B015G030L057	29	01	0.15	FM Choice
1024430	FP300D2901P015U025L057H	29	01	0.15	FM Choice

FINE PITCH PROBES - PITCH 0.30 - 0.50 MM



FP350D-L069

0.50 mm Pitch | Double acting | High temperature version

Electrical specifications

Current [A]	2.0	
R _{TYP} [mOhm]	<66	
Self Inductance [nH]	2.22	
Frequency at -1dB [GHz]	Socket	Probe Card
	27	26.5

Mechanical specifications

Temperature [°C]	-45°...+150°	
Preload [cN]	8	
Spring force at nt [cN ±20%]	20	
Nominal travel [mm]	0.65	
Maximum travel [mm]	0.75	

Materials and plating

Top Plunger	BeCu	gold plated
Bottom Plunger	BeCu	gold plated
Barrel	Nickel	gold plated
Spring	Stainless steel	gold plated

Drill size recommendation [mm]

Equal barrel diameter	0.36 - 0.38
-----------------------	-------------

Series drawing

All measurements are in mm.

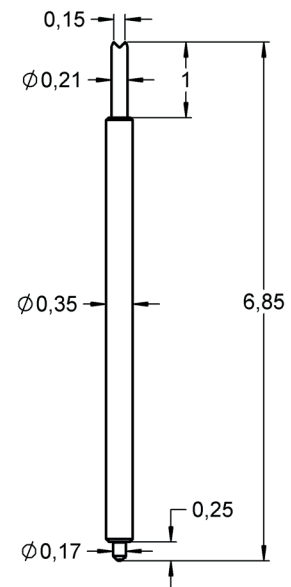

Radio frequency performance [GHz]

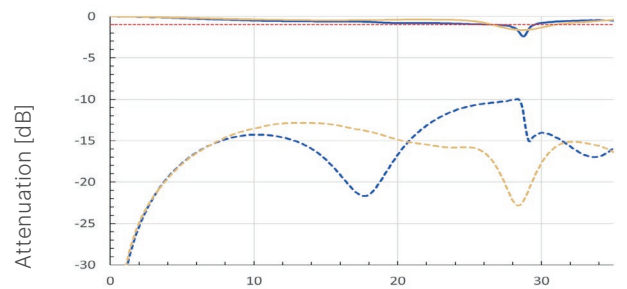

Frequency [GHz]

Caption legend p.11

Order code	Product name	Top plunger	Bottom plunger	Ø in mm	FM Choice
1023460	FP350D0301B025G020L069	03	01	0.25	-
1023459	FP350D2901B021G020L069	29	01	0.21	-

FINE PITCH PROBES - PITCH 0.30 - 0.50 MM



FP350D-L076

0.50 mm Pitch | Double acting | High temperature version

Electrical specifications

Current [A]	2.0	
R _{TYP} [mOhm]	<80	
Self Inductance [nH]	2.50	
	Socket	Probe Card
Frequency at -1dB [GHz]	23	22

Mechanical specifications

Temperature [°C]	-45°...+150°	
Preload [cN]	8	
Spring force at nt [cN ±20%]	20	
Nominal travel [mm]	0.65	
Maximum travel [mm]	0.75	

Materials and plating

Top Plunger	BeCu	gold plated
Bottom Plunger	BeCu	gold plated
Barrel	Bronze	gold plated
Spring	Stainless steel	gold plated

Drill size recommendation [mm]

Equal barrel diameter	0.36 - 0.38
-----------------------	-------------

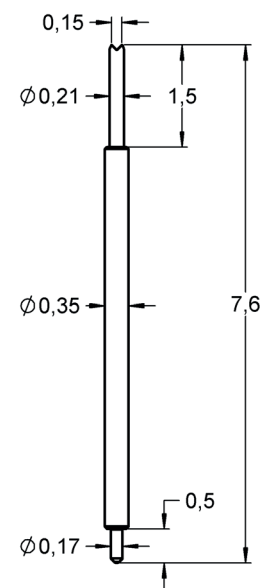

Series drawing

All measurements are in mm.

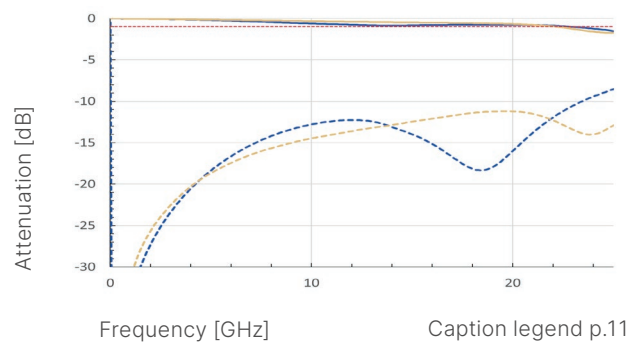

Radio frequency performance [GHz]



Order code	Product name	Top plunger	Bottom plunger	Ø in mm	FM Choice
1114002	FP350D2901B021G020L076	29 	01 	0.21	-

FINE PITCH PROBES - PITCH 0.30 - 0.50 MM

FM Choice

FP380D-L030

0.50 mm Pitch | Double acting



Electrical specifications

Current [A]	1.1	
R _{TYP} [mOhm]	<100	
Self Inductance [nH]	0.81	
	Socket	Probe Card
Frequency at -1dB [GHz]	21.5	44

Mechanical specifications

Temperature [°C]	-45°...+120°	
Preload [cN]	15	
Spring force at nt [cN ±20%]	25	
Nominal travel [mm]	0.40	
Maximum travel [mm]	0.55	

Materials and plating

Top Plunger	Palladium alloy	unplated
Bottom Plunger	BeCu	gold plated
Barrel	Nickel	gold plated
Spring	Spring steel	gold plated

Drill size recommendation [mm]

Equal barrel diameter	0.39 - 0.41
-----------------------	-------------

Series drawing

All measurements are in mm.

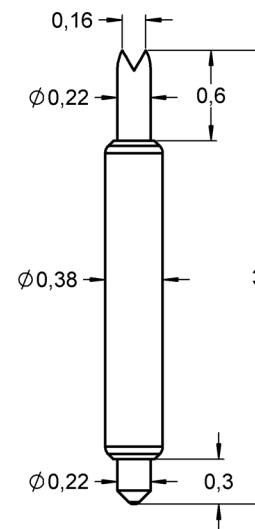

Radio frequency performance [GHz]

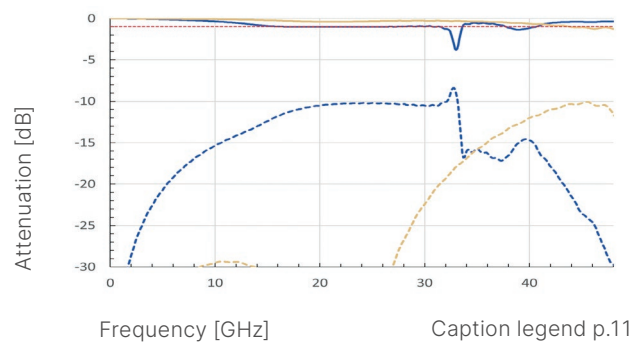

Order code	Product name	Top plunger	Bottom plunger	Ø in mm	FM Choice
1023006	FP380D2901P022U025L030	29	01	0.22	

FINE PITCH PROBES - PITCH 0.30 - 0.50 MM

FM Choice

FP380D-L032

0.50 mm Pitch | Double acting



Electrical specifications

Current [A]	1.1	
R _{TYP} [mOhm]	<100	
Self Inductance [nH]	0.82	
	Socket	Probe Card
Frequency at -1dB [GHz]	16	45

Mechanical specifications

Temperature [°C]	-45°...+120°	
Preload [cN]	8	
Spring force at nt [cN ±20%]	23	
Nominal travel [mm]	0.55	
Maximum travel [mm]	0.65	

Materials and plating

Top Plunger	BeCu	gold plated
	Palladium alloy	unplated
Bottom Plunger	BeCu	gold plated
Barrel	Bronze	gold plated
Spring	Spring steel	gold plated

Drill size recommendation [mm]

Equal barrel diameter	0.39 - 0.41
-----------------------	-------------

Series drawing

All measurements are in mm.

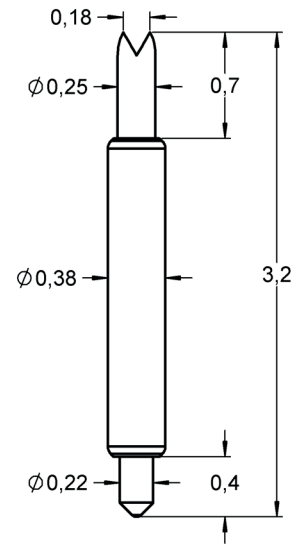

Radio frequency performance [GHz]

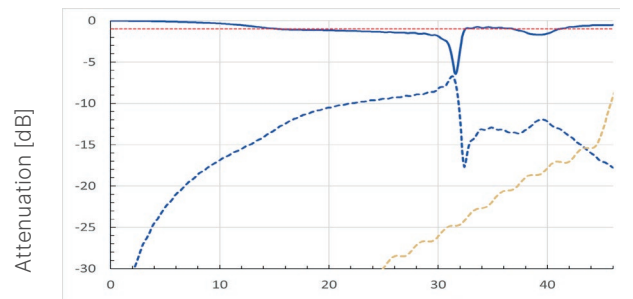

Frequency [GHz]

Caption legend p.11

Order code	Product name	Top plunger	Bottom plunger	Ø in mm	FM Choice
1127923	FP380D0301B025G023L032	03	01	0.25	FM Choice
1127922	FP380D2901B025G023L032	29	01	0.25	FM Choice
1127921	FP380D2901P025U023L032	29	01	0.25	FM Choice

FINE PITCH PROBES - PITCH 0.30 - 0.50 MM

FM Choice

FP380D-L057

0.50 mm Pitch | Double acting | High temperature version



Electrical specifications

Current [A]	1.6	
R _{TYP} [mOhm]	<75	
Self Inductance [nH]	1.57	
	Socket	Probe Card
Frequency at -1dB [GHz]	12	28

Mechanical specifications

Temperature [°C]	-45°...+150°	
Preload [cN]	4.5	
Spring force at nt [cN ±20%]	24	
Nominal travel [mm]	0.65	
Maximum travel [mm]	0.80	

Materials and plating

Top Plunger	BeCu	gold plated
	Palladium alloy	unplated
Bottom Plunger	BeCu	gold plated
Barrel	Bronze	gold plated
Spring	Stainless steel	gold plated

Drill size recommendation [mm]

Equal barrel diameter	0.39 - 0.41
-----------------------	-------------

Series drawing

All measurements are in mm.

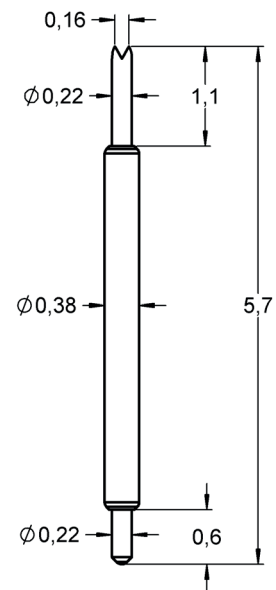

Radio frequency performance [GHz]

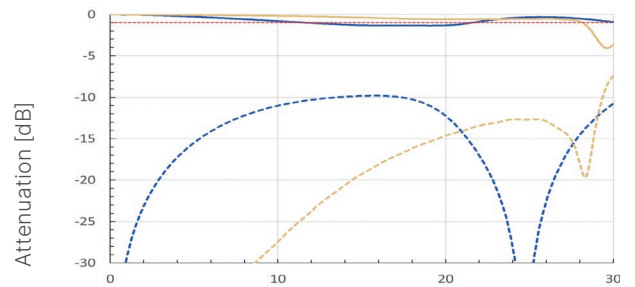

Frequency [GHz]

Caption legend p.11

Order code	Product name	Top plunger	Bottom plunger	Ø in mm	FM Choice
1127691	FP380D0103B022G024L057	01	03	0.22	FM Choice
1127689	FP380D2903B022G024L057	29	03	0.22	FM Choice
1127686	FP380D2903P022U024L057	29	03	0.22	FM Choice

FINE PITCH PROBES - PITCH 0.30 - 0.50 MM



FP380D-L087

0.50 mm Pitch | Double acting | High temperature version

Electrical specifications

Current [A]	2.0	
R _{TYP} [mOhm]	<66	
Self Inductance [nH]	2.37	
	Socket	Probe Card
Frequency at -1dB [GHz]	7.5	19.5

Mechanical specifications

Temperature [°C]	-45°...+150°	
Preload [cN]	12	
Spring force at nt [cN ±20%]	30	
Nominal travel [mm]	1.0	
Maximum travel [mm]	1.2	

Materials and plating

Top Plunger	Palladium alloy	unplated
Bottom Plunger	BeCu	gold plated
Barrel	Nickel	gold plated
Spring	Stainless steel	gold plated

Drill size recommendation [mm]

Equal barrel diameter	0.39 - 0.41
-----------------------	-------------

Series drawing

All measurements are in mm.

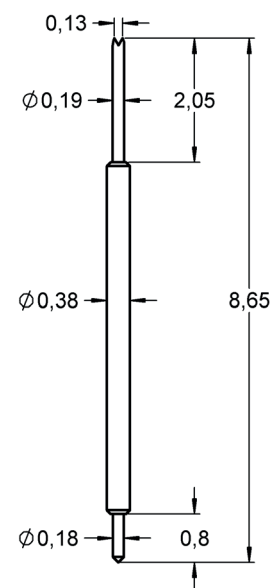

Radio frequency performance [GHz]

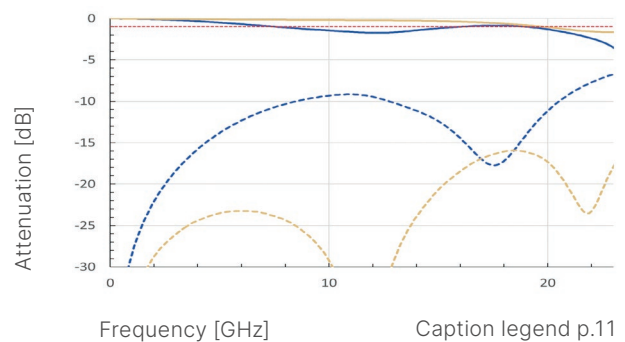

Order code	Product name	Top plunger	Bottom plunger	Ø in mm	FM Choice
1024574	FP380D2901P019U030L087	29	01	0.19	

FINE PITCH PROBES - PITCH 0.30 - 0.50 MM



FP380S-L203

0.50 mm Pitch | Single acting

Electrical specifications

Current [A]	1.0
R _{TYP} [mOhm]	<250

Mechanical specifications

Temperature [°C]	-45°...+100°
Preload [cN]	10
Spring force at nt [cN ±20%]	50
Nominal travel [mm]	2.0
Maximum travel [mm]	2.5

Materials and plating

Top Plunger	BeCu	longtime gold plated
Barrel	Bronze	gold plated
Spring	Stainless steel	unplated
Connecting element	BeCu	gold plated

Accessories

1004049	H380DR	Connecting element
---------	--------	--------------------

Drill size recommendation [mm]

Equal barrel diameter	0.39 - 0.41
-----------------------	-------------

Series drawing

All measurements are in mm.

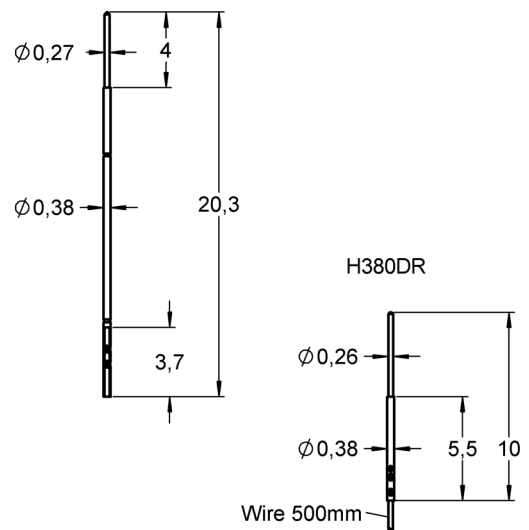

Order code	Product name	Top plunger	Bottom plunger	Ø in mm	FM Choice
1003134	FP380S01B027L050L203	01 	-	0.27	

FINE PITCH PROBES - PITCH 0.30 - 0.50 MM

FP380D-L243

0.50 mm Pitch | Double acting



Electrical specifications

Current [A]	1.0	
R _{TYP} [mOhm]	<250	
Self Inductance [nH]	6.91	
	Socket	Probe Card
Frequency at -1dB [GHz]	7.5	-

Mechanical specifications

Temperature [°C]	-45°...+100°	
Preload [cN]	10	
Spring force at nt [cN ±20%]	50	
Nominal travel [mm]	2.0	
Maximum travel [mm]	2.5	

Materials and plating

Top Plunger	BeCu	longtime gold plated
Bottom Plunger	BeCu	longtime gold plated
Barrel	Bronze	gold plated
Spring	Stainless steel	gold plated

Drill size recommendation [mm]

Equal barrel diameter	0.39 - 0.41
-----------------------	-------------

Series drawing

All measurements are in mm.

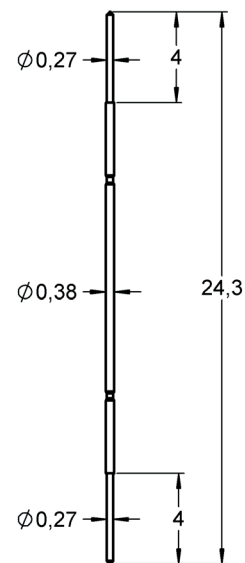

Radio frequency performance [GHz]

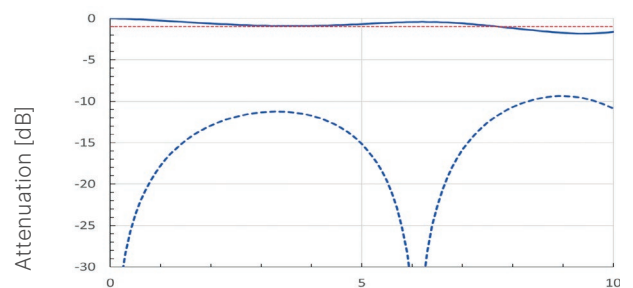

Frequency [GHz]

Caption legend p.11

Order code	Product name	Top plunger	Bottom plunger	Ø in mm	FM Choice
1003136	FP380D0101B027L050L243	01	01	0.27	
1003137	FP380D1111B027L050L243	11	11	0.27	

FINE PITCH PROBES - PITCH > 0.50 MM



FP350DF-L035

0.55 mm Pitch | Single acting

Electrical specifications

Current [A]	2.0
R _{TYP} [mOhm]	<100
Self Inductance [nH]	1.09
Frequency at -1dB [GHz]	37

Mechanical specifications

Temperature [°C]	-45°...+120°
Preload [cN]	7
Spring force at nt [cN ±20%]	38
Nominal travel [mm]	0.45
Maximum travel [mm]	0.60

Materials and plating

Top Plunger (rigid)	Palladium alloy	unplated
Bottom Plunger	BeCu	gold plated
Barrel	Bronze	gold plated
Spring	Spring steel	gold plated

Drill size recommendation [mm]

Equal barrel diameter	0.31 - 0.33
-----------------------	-------------

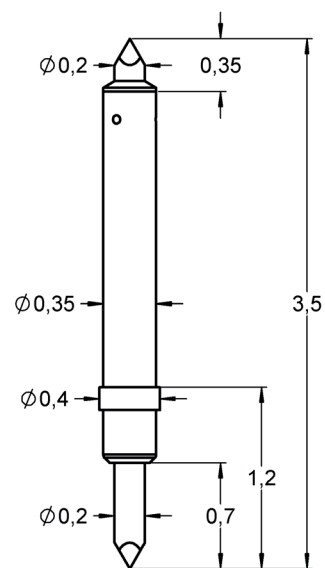

Series drawing

All measurements are in mm.

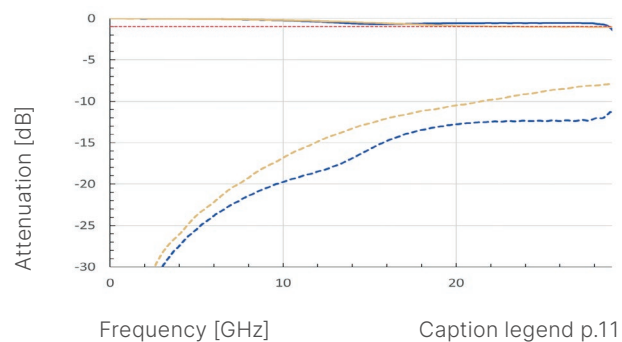

Radio frequency performance [GHz]



Order code	Product name	Top plunger	Bottom plunger	Ø in mm	FM Choice
1142148	FP350DF3030P020U038L035	30 	30 	0.20	

FINE PITCH PROBES - PITCH > 0.50 MM



FP420S-L198 / FP420S-L239

0.60 mm Pitch | Single acting

Electrical specifications

Current [A]	2.0	
R _{TYP} [mOhm]	<150	
Self Inductance [nH]	7.85	
	Socket	Probe Card
Frequency at -1dB [GHz]	3.5	-

Mechanical specifications

Temperature [°C]	-45°...+100°
Preload [cN]	10
Spring force at nt [cN ±20%]	40
Nominal travel [mm]	2.0
Maximum travel [mm]	3.0

Materials and plating

Top Plunger	BeCu	gold plated
Barrel	Bronze	gold plated
Spring	Spring steel	gold plated
Connecting element	BeCu	gold plated

Accessories

1029876	H420AE	Connecting element
---------	--------	--------------------

Drill size recommendation [mm]

Equal barrel diameter	0.43 - 0.45
-----------------------	-------------

Series drawing

All measurements are in mm.

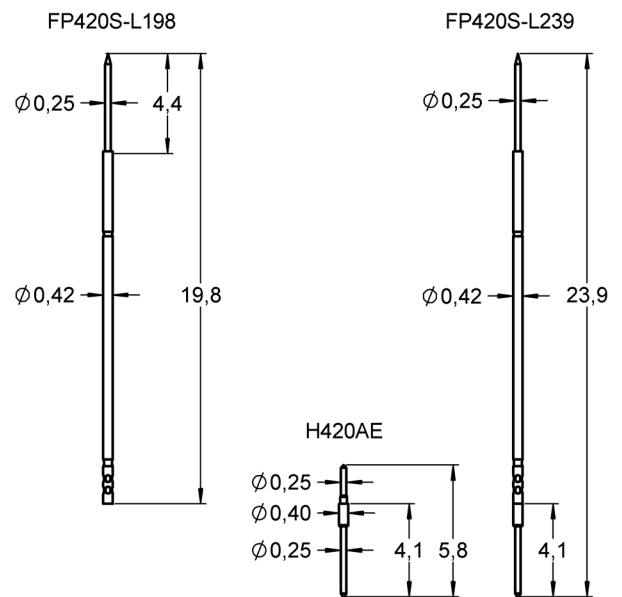

Radio frequency performance [GHz]

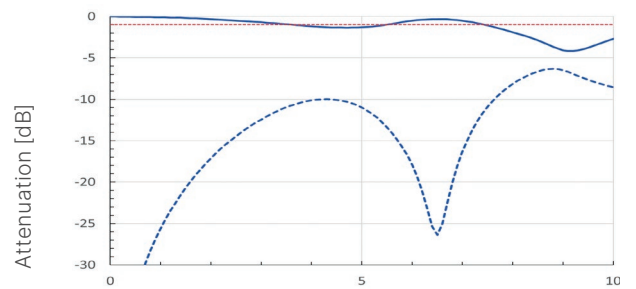

Frequency [GHz]

Caption legend p.11

Order code	Product name	Top plunger	Bottom plunger	Ø in mm	FM Choice
1029861	FP420S18B025G040L198	18	-	0.25	
1029877	FP420S18B025G040L239AE	18	-	0.25	

FINE PITCH PROBES - PITCH > 0.50 MM



FP480D-L046NM

0.65 mm Pitch | Double acting |
High temperature | Non-magnetic

Electrical specifications

Current [A]	2.3	
R _{TYP} [mOhm]	<56	
Self Inductance [nH]	1.38	
Frequency at -1dB [GHz]	Socket	Probe Card
	12	32

Mechanical specifications

Temperature [°C]	-45°...+200°	
Preload [cN]	20	
Spring force at nt [cN ±20%]	46	
Nominal travel [mm]	0.4	
Maximum travel [mm]	0.6	

Materials and plating

Top Plunger	BeCu	gold plated
Bottom Plunger	BeCu	gold plated
Barrel	Bronze	gold plated
Spring	Stainless steel	gold plated

Drill size recommendation [mm]

Equal barrel diameter	0.49 - 0.51
-----------------------	-------------

Series drawing

All measurements are in mm.

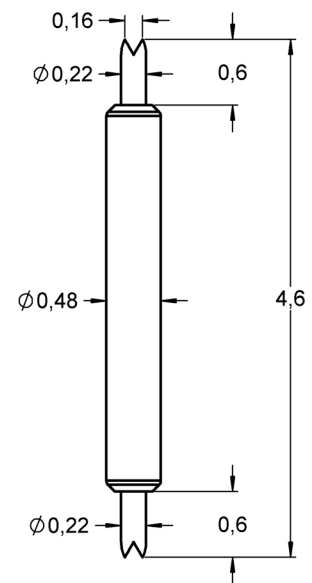

Radio frequency performance [GHz]

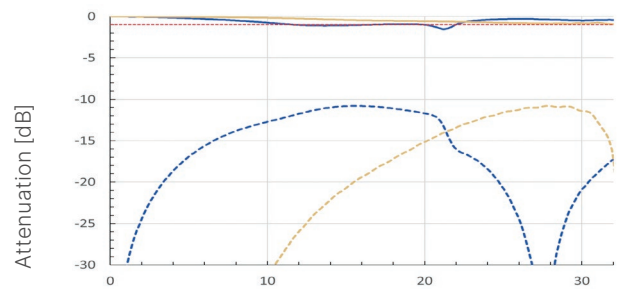

Frequency [GHz]

Caption legend p.11

Order code	Product name	Top plunger	Bottom plunger	Ø in mm	FM Choice
1031177	FP480D2929B022G046L046NM	29	29	0.22	

FINE PITCH PROBES - PITCH > 0.50 MM



FP480S-L158

0.75 mm Pitch | Single acting

Electrical specifications

Current [A]	1.0	
R _{TYP} [mOhm]	<65	
Self Inductance [nH]	5.10	
Frequency at -1dB [GHz]	Socket	Probe Card
	12	21.5

Mechanical specifications

Temperature [°C]	-45°...+100°	
Preload [cN]	20	
Spring force at nt [cN ±20%]	50	
Nominal travel [mm]	0.4	
Maximum travel [mm]	0.6	

Materials and plating

Top Plunger	BeCu	gold plated
Barrel	Bronze	gold plated
Spring	Spring steel	silver plated
Receptacle	Bronze	gold plated

Accessories

1001688	H480CR	receptacle
1001689	H480LI	receptacle
1054103	FEWZ-109E0	insertion tool receptacle

Drill size recommendation [mm]

With receptacle H480...	0.66 - 0.68
Equal barrel diameter	0.49 - 0.51

Series drawing

All measurements are in mm.

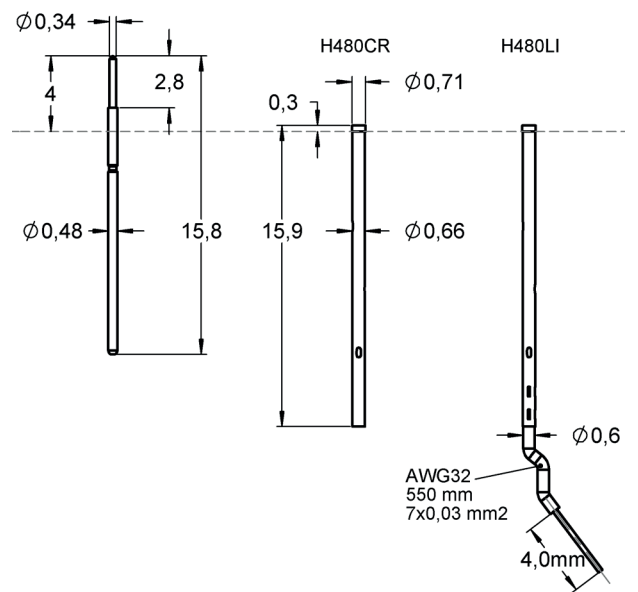

Radio frequency performance [GHz]

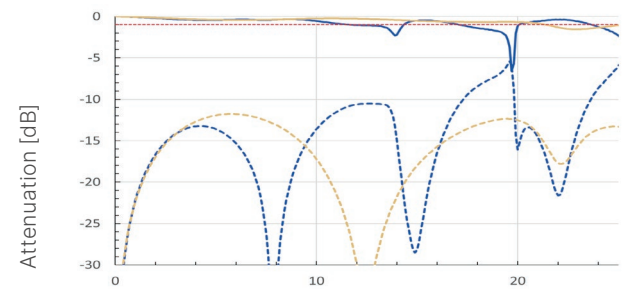

Frequency [GHz]

Caption legend p.11

Order code	Product name	Top plunger	Bottom plunger	Ø in mm	FM Choice
1001399	FP480S01B034G050L158	01	-	0.34	
1001400	FP480S18B034G050L158	18	-	0.34	

FINE PITCH PROBES - PITCH > 0.50 MM



FP510D-L166

0.70 mm Pitch | Double acting

Electrical specifications

Current [A]	1.0	
R _{TYP} [mOhm]	<70	
Self Inductance [nH]	4.90	
	Socket	Probe Card
Frequency at -1dB [GHz]	10	18

Mechanical specifications

Temperature [°C]	-45°...+100°	
Preload [cN]	10	10
Spring force at nt [cN ±20%]	25	50
Nominal travel [mm]	2.0	2.0
Maximum travel [mm]	2.5	2.5

Materials and plating

Top Plunger	BeCu	gold plated
Bottom Plunger	BeCu	gold plated
Barrel	Bronze	gold plated
Spring	Spring steel	silver plated

Drill size recommendation [mm]

Equal barrel diameter	0.52 - 0.54
-----------------------	-------------

Series drawing

All measurements are in mm.

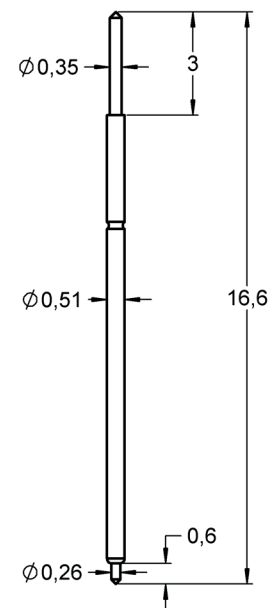

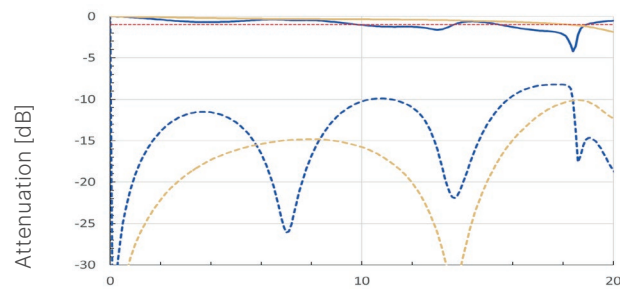

Radio frequency performance [GHz]



Frequency [GHz]

Caption legend p.11

Order code	Product name	Top plunger	Bottom plunger	Ø in mm	FM Choice
1001356	FP510D0101B035G050L166	01 	01 	0.35	

FINE PITCH PROBES - PITCH > 0.50 MM



FP510S-L203

0.70 mm Pitch | Single acting

Electrical specifications

Current [A]	1.0
R _{TYP} [mOhm]	<70

Mechanical specifications

Temperature [°C]	-45°...+100°
Preload [cN]	10
Spring force at nt [cN ±20%]	50
Nominal travel [mm]	2.0
Maximum travel [mm]	2.5

Materials and plating

Top Plunger	Steel	longtime gold plated
Barrel	Bronze	gold plated
Spring	Spring steel	gold plated
Connecting element	BeCu	gold plated

Accessories

1005349	H510DR	Connecting element
---------	--------	--------------------



Drill size recommendation [mm]

Equal barrel diameter	0.52 - 0.54
-----------------------	-------------

Series drawing

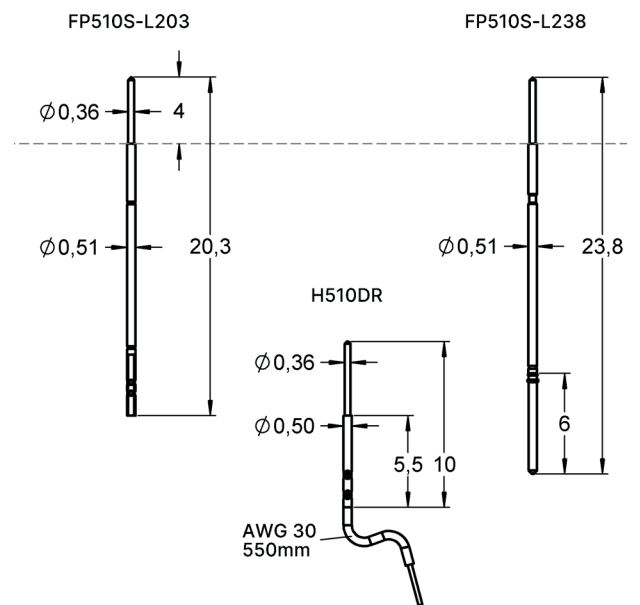
All measurements are in mm.



Order code	Product name	Top plunger	Bottom plunger	Ø in mm	FM Choice
1003758	FP510S01S036L050L203	01 	-	0.36	
1007267	FP510S01S036L050L238	01 		0.36	

FINE PITCH PROBES - PITCH > 0.50 MM



FP510D-L243

0.70 mm Pitch | Double acting

Electrical specifications

Current [A]	1.0	
R _{TYP} [mOhm]	<70	
Self Inductance [nH]	7.48	
Frequency at -1dB [GHz]	Socket	Probe Card
	7	-

Mechanical specifications

Temperature [°C]	-45°...+100° -45°...+200° (H)	
Preload [cN]	10	10
Spring force at nt [cN ±20%]	(H) 40	50
Nominal travel [mm]	2.0	2.0
Maximum travel [mm]	2.5	2.5

Materials and plating

Top Plunger	BeCu	gold plated
Bottom Plunger	BeCu	gold plated
Barrel	Bronze	gold plated
Spring	Spring steel Stainless steel (H)	silver plated unplated

Drill size recommendation [mm]

Equal barrel diameter	0.52 - 0.54
-----------------------	-------------

Series drawing

All measurements are in mm.

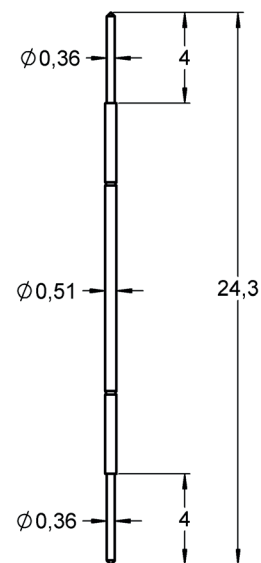

Radio frequency performance [GHz]

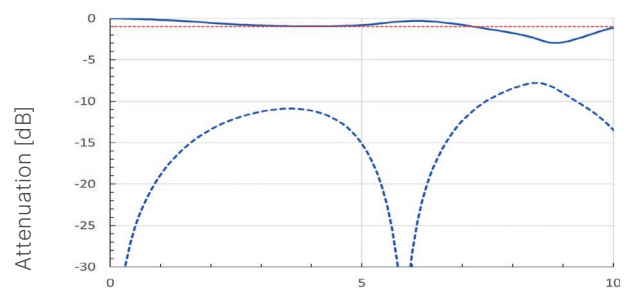

Frequency [GHz]

Caption legend p.11

Order code	Product name	Top plunger	Bottom plunger	Ø in mm	FM Choice
1013358	FP510D0101S036L040L243H	01	01	0.36	
1005083	FP510D0101S036L050L243	01	01	0.36	

FINE PITCH PROBES - PITCH > 0.50 MM

FM Choice

FP570D-L057

0.80 mm Pitch | Double acting | High temperature version



Electrical specifications

Current [A]	3.8	
R _{TYP} [mOhm]	<60	
Self Inductance [nH]	1.76	
	Socket	Probe Card
Frequency at -1dB [GHz]	15.5	25.5

Mechanical specifications

Temperature [°C]	-45°...+150°	
Preload [cN]	10	
Spring force at nt [cN ±20%]	30	
Nominal travel [mm]	0.65	
Maximum travel [mm]	0.85	

Materials and plating

Top Plunger	BeCu	gold plated
Bottom Plunger	BeCu	gold plated
Barrel	Bronze	gold plated
Spring	Stainless steel	gold plated

Drill size recommendation [mm]

Equal barrel diameter	0.58 - 0.61
-----------------------	-------------

Series drawing

All measurements are in mm.

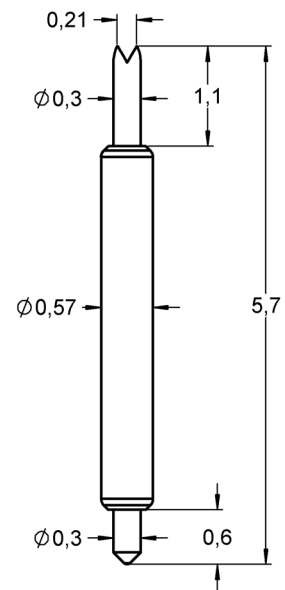

Radio frequency performance [GHz]

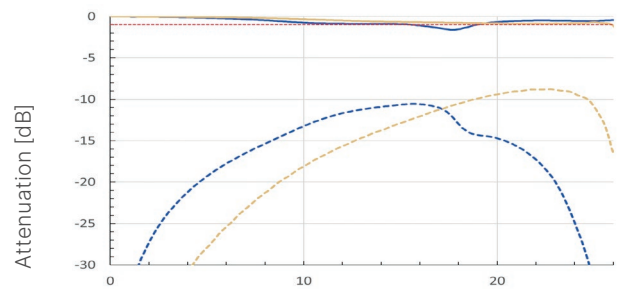

Frequency [GHz]

Caption legend p.11

Order code	Product name	Top plunger	Bottom plunger	Ø in mm	FM Choice
1128177	FP570D0101B030G030L057	01	01	0.30	FM Choice
1128176	FP570D2901B030G030L057	29	01	0.30	FM Choice

FINE PITCH PROBES - PITCH > 0.50 MM



FP580D-L058NM

0.80 mm Pitch | Double acting |
High temperature | Non-magnetic

Electrical specifications

Current [A]	3.5	
R _{TYP} [mOhm]	<60	
Self Inductance [nH]	1.79	
	Socket	Probe Card
Frequency at -1dB [GHz]	28.5	26

Mechanical specifications

Temperature [°C]	-45°...+150°	
Preload [cN]	30	
Spring force at nt [cN ±20%]	60	
Nominal travel [mm]	0.5	
Maximum travel [mm]	0.6	

Materials and plating

Top Plunger	BeCu	gold plated
Bottom Plunger	BeCu	gold plated
Barrel	Bronze	gold plated
Spring	Stainles steel	gold plated

Drill size recommendation [mm]

Equal barrel diameter	0.59 - 0.62
-----------------------	-------------

Series drawing

All measurements are in mm.

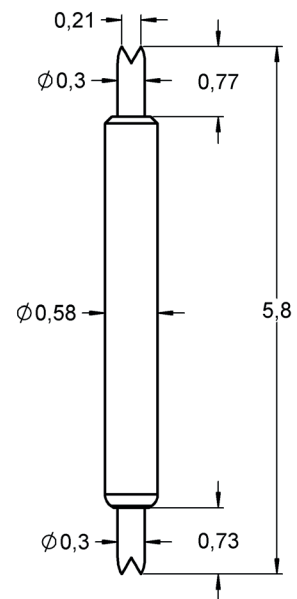

Radio frequency performance [GHz]

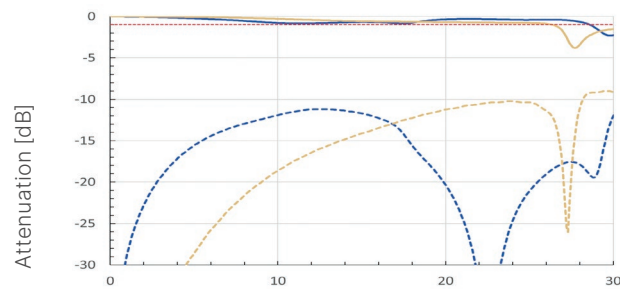

Frequency [GHz]

Caption legend p.11

Order code	Product name	Top plunger	Bottom plunger	Ø in mm	FM Choice
1028445	FP580D2929B030G060L058NM	29	29	0.30	

FINE PITCH PROBES - PITCH > 0.50 MM



FP580D-L059NM

0.80 mm Pitch | Non-magnetic

Electrical specifications

Current [A]	3.5		
R _{TYP} [mOhm]	<60		
Self Inductance [nH]	1.80		
	Socket	Probe Card	
Frequency at -1dB [GHz]	28.5	26	

Mechanical specifications

Temperature [°C]	-45°...+100° -45°...+200° (H)		
Preload [cN]	30	30	30
Spring force at nt [cN ±20%]	20	40	60
Nominal travel [mm]	0.5	0.5	0.5
Maximum travel [mm]	0.6	0.6	0.6

Materials and plating

Top Plunger	BeCu	gold plated
Bottom Plunger	BeCu	gold plated
Barrel	Bronze	gold plated
Spring	Spring steel Stainles steel (H)	silver plated unplated

Drill size recommendation [mm]

Equal barrel diameter	0.59 - 0.62
-----------------------	-------------

Series drawing

All measurements are in mm.

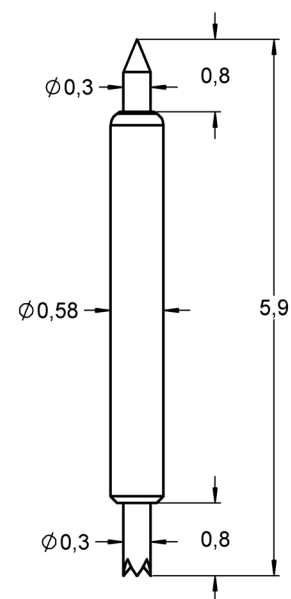

Radio frequency performance [GHz]

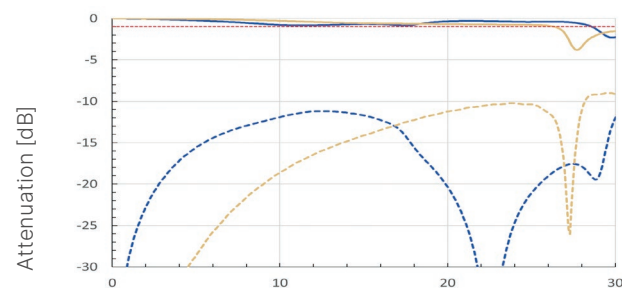

Frequency [GHz]

Caption legend p.11

Order code	Product name	Top plunger	Bottom plunger	Ø in mm	FM Choice
1003844	FP580D0329B030G020L059	03	29	0.30	
1093730	FP580D1111B030G060L059HS1	11	11	0.30	
1001489	FP580D1629B030G040L059	16	29	0.30	
1025408	FP580D2903B030G060L059HS1	29	03	0.30	
1001490	FP580D2929B030G040L059	29	29	0.30	

FINE PITCH PROBES - PITCH > 0.50 MM



FP590D-L087

0.80 mm Pitch | Double acting | High temperature version

Electrical specifications

Current [A]	2.5	
R _{TYP} [mOhm]	<100	
Self Inductance [nH]	2.61	
	Socket	Probe Card
Frequency at -1dB [GHz]	8.5	17

Mechanical specifications

Temperature [°C]	-45°...+150°	
Preload [cN]	10	
Spring force at nt [cN ±20%]	35	
Nominal travel [mm]	0.75	
Maximum travel [mm]	1.00	

Materials and plating

Top Plunger	Steel	gold plated
Bottom Plunger	Steel	gold plated
Barrel	Bronze	gold plated (inside)
Spring	Stainles steel	gold plated

Drill size recommendation [mm]

Equal barrel diameter	0.60 - 0.63
-----------------------	-------------

Series drawing

All measurements are in mm.

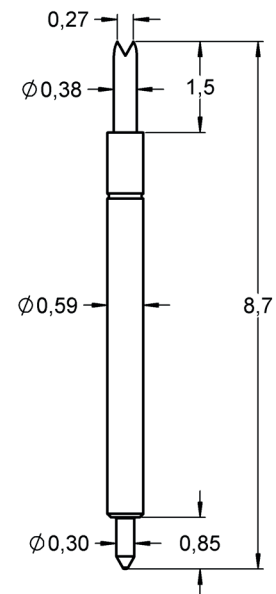

Radio frequency performance [GHz]

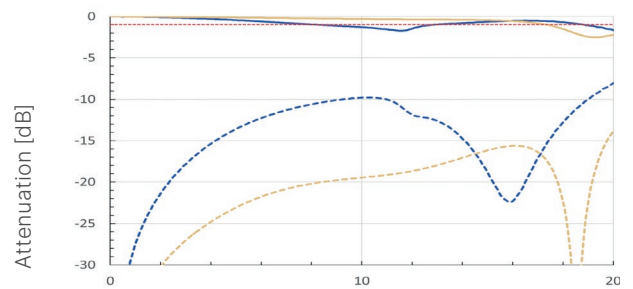

Frequency [GHz]

Caption legend p.11

Order code	Product name	Top plunger	Bottom plunger	Ø in mm	FM Choice
1023461	FP590D0303S038G035L087	03	03	0.38	
1023462	FP590D2903S038G035L087	29	03	0.38	

FINE PITCH PROBES - PITCH > 0.50 MM

FM Choice

FP650D-L057

0.80 mm Pitch | Double acting | High temperature version



Electrical specifications

Current [A]	4.0	
R _{typ} [mOhm]	<50	
Self Inductance [nH]	1.35	
	Socket	Probe Card
Frequency at -1dB [GHz]	7.5	25

Mechanical specifications

Temperature [°C]	-45°...+150°	
Preload [cN]	7	
Spring force at nt [cN ±20%]	30	
Nominal travel [mm]	0.65	
Maximum travel [mm]	0.85	

Materials and plating

Top Plunger	BeCu	gold plated
Bottom Plunger	BeCu	gold plated
Barrel	Bronze	gold plated
Spring	Stainles steel	gold plated

Drill size recommendation [mm]

Equal barrel diameter	0.66 - 0.69
-----------------------	-------------

Series drawing

All measurements are in mm.

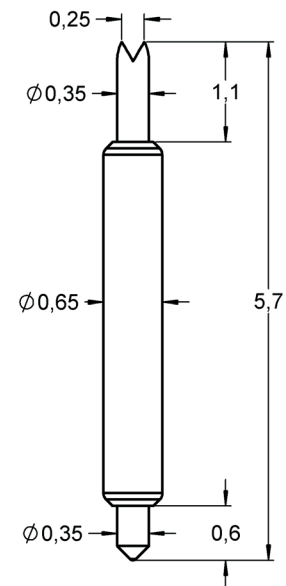

Radio frequency performance [GHz]

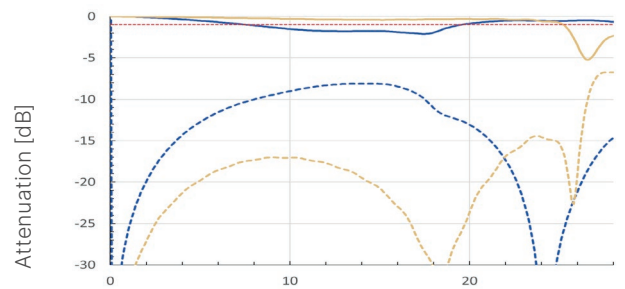

Frequency [GHz]

Caption legend p.11

Order code	Product name	Top plunger	Bottom plunger	Ø in mm	FM Choice
1131068	FP650D0301B035G030L057	03	01	0.35	FM Choice
1131051	FP650D2901B035G030L057	29	01	0.35	FM Choice

FINE PITCH PROBES - PITCH > 0.50 MM



FP680D-L245

1.00 mm Pitch | Double acting

Electrical specifications

Current [A]	1.5	
R _{TYP} [mOhm]	<75	
Self Inductance [nH]	5.27	
Frequency at -1dB [GHz]	Socket	Probe Card
	1.5	-

Mechanical specifications

Temperature [°C]	-45°...+100°	
Preload [cN]	35	
Spring force at nt [cN ±20%]	85	
Nominal travel [mm]	2.0	
Maximum travel [mm]	2.5	

Materials and plating

Top Plunger	Steel	gold plated
Bottom Plunger	Steel	gold plated
Barrel	Bronze	silver plated
Spring	Spring steel	silver plated

Drill size recommendation [mm]

Equal barrel diameter	0.69 - 0.72
-----------------------	-------------

Series drawing

All measurements are in mm.

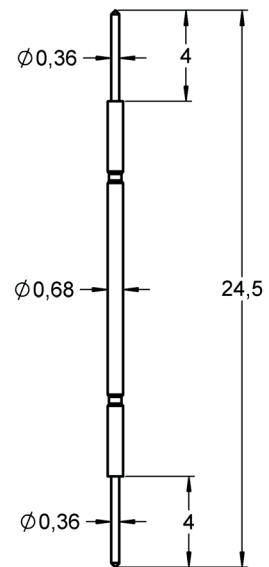



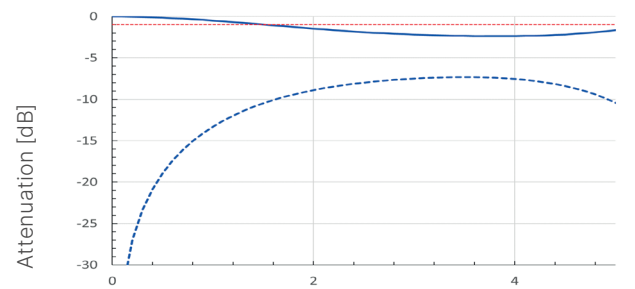

Radio frequency performance [GHz]



Frequency [GHz]

Caption legend p.11

Order code	Product name	Top plunger	Bottom plunger	Ø in mm	FM Choice
1035969	FP680D0101S036L085L245	01 	01 	0.36	
1035970	FP680D1111S036L085L245	11 	11 	0.36	

FINE PITCH PROBES - PITCH > 0.50 MM



FP680S-L247

1.27 mm Pitch | Single acting

Electrical specifications

Current [A]	2.0
R _{TYP} [mOhm]	<25

Mechanical specifications

Temperature [°C]	-45°...+100°
Preload [cN]	20
Spring force at nt [cN ±20%]	65
Nominal travel [mm]	4.0
Maximum travel [mm]	6.5

Materials and plating

Top Plunger	Steel	nickel plated
Barrel	Bronze	silver plated
Spring	Spring steel	silver plated
Receptacle	Bronze	gold plated

Accessories

1008513	H680-5.7	receptacle
1000180	FEWZ-040E0	insertion tool receptacle

Drill size recommendation [mm]

Equal barrel diameter	0.69 - 0.73
Receptacle	1.66 - 1.68

Series drawing

All measurements are in mm.

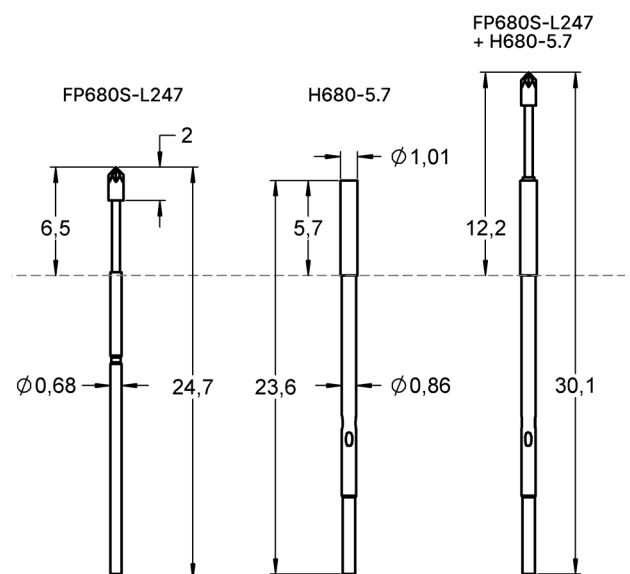

Order code	Product name	Top plunger	Bottom plunger	Ø in mm	FM Choice
1053964	FP680S07S090N065L247	07	-	0.90	

FP750S-L245

1.00 mm Pitch | Single acting



Electrical specifications

Current [A]	2.0	
R _{TYP} [mOhm]	<50	
Self Inductance [nH]	8.02	
	Socket	Probe Card
Frequency at -1dB [GHz]	7.5	13.5

Mechanical specifications

Temperature [°C]	-45°...+100°	
Preload [cN]	10	
Spring force at nt [cN ±20%]	20	
Nominal travel [mm]	0.5	
Maximum travel [mm]	2.2	

Materials and plating

Top Plunger	BeCu	gold plated
Barrel	Bronze	gold plated
Spring	Spring steel	silver plated

Drill size recommendation [mm]

Equal barrel diameter	0.74 - 0.76
-----------------------	-------------

Series drawing

All measurements are in mm.

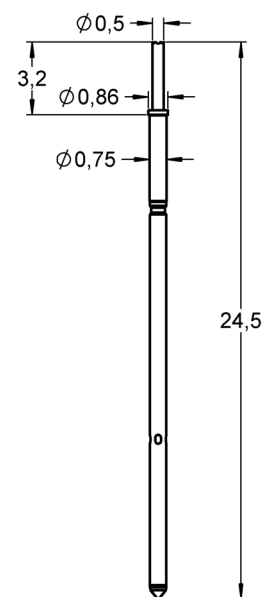

Radio frequency performance [GHz]

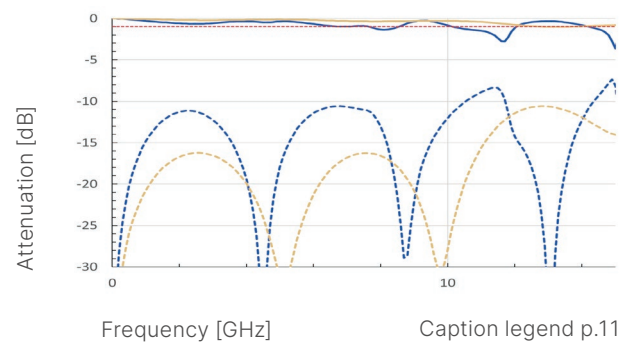

Order code	Product name	Top plunger	Bottom plunger	Ø in mm	FM Choice
1008296	FP750S09B050G020L245	09 	-	0.50	

FINE PITCH PROBES - PITCH > 0.50 MM

FM Choice

FP800D-L057

1.00 mm Pitch | Double acting | High temperature version



Electrical specifications

Current [A]	3.5	
R _{TYP} [mOhm]	<55	
Self Inductance [nH]	1.40	
	Socket	Probe Card
Frequency at -1dB [GHz]	7	23.5

Mechanical specifications

Temperature [°C]	-45°...+150°	
Preload [cN]	10	
Spring force at nt [cN ±20%]	25	
Nominal travel [mm]	0.65	
Maximum travel [mm]	0.85	

Materials and plating

Top Plunger	BeCu	gold plated
Bottom Plunger	BeCu	gold plated
Barrel	Bronze	gold plated
Spring	Stainles steel	gold plated

Drill size recommendation [mm]

Equal barrel diameter	0.81 - 0.83
-----------------------	-------------

Series drawing

All measurements are in mm.

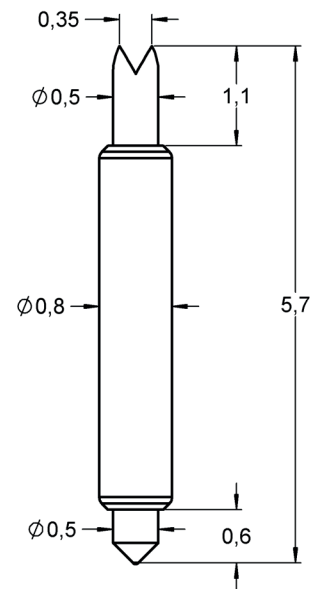

Radio frequency performance [GHz]

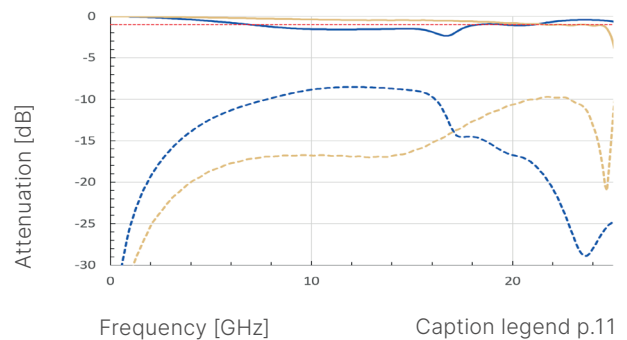

Order code	Product name	Top plunger	Bottom plunger	Ø in mm	FM Choice
1130443	FP800D0301B050G025L057	03	01	0.50	FM Choice
1130428	FP800D2901B050G025L057	29	01	0.50	FM Choice

INTERFACE SOLUTIONS



IN GENERAL

Spring Contact Probes as an interface offer many advantages in the field of signal transmission, power transfer and data exchange between different devices or circuits. FEINMETALL's Interface Probes provide a reliable electrical connection with a stable low resistance.

This stability contributes to the overall integrity of data transmission. FEINMETALL uses its advanced expertise in Interface Probes to offer various Interface Solutions:

Interface Blocks

FEINMETALL Interface Blocks are used for the reliable transmission of signals between test instrument and test system / test fixture in internal, external and customer-specific interfaces. An electrical interface via spring-loaded interface blocks ensures consistently high contact quality and reliable signal transmission with consistently low contact resistance. Various designs of signal, high-current, high-frequency and special blocks are available for a wide range of applications.



Pogo Tower

In Semiconductor Testing, a Pogo Tower is a crucial interface component that ensures a reliable electrical connection between the tester and the probe card. FEINMETALL's Pogo Tower solutions are engineered to ensure optimal contact safety, superior signal integrity, and outstanding performance.

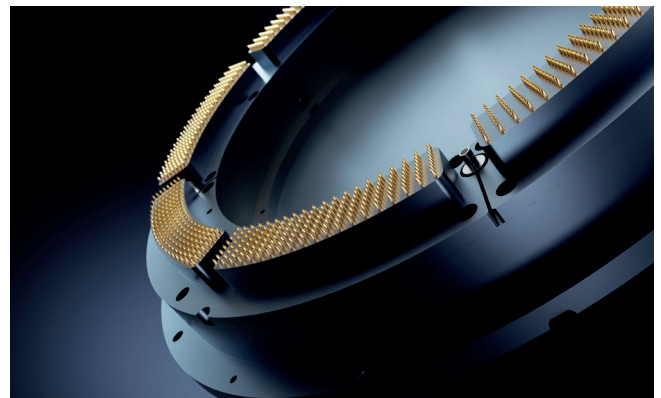

Interposer

Interposers are used in the semiconductor industry to establish connection between two boards. FEINMETALL Interposer provide a robust solution for board-to-board connections ensuring seamless electrical contact in Semiconductor Testing. They are designed for low resistance and high durability.

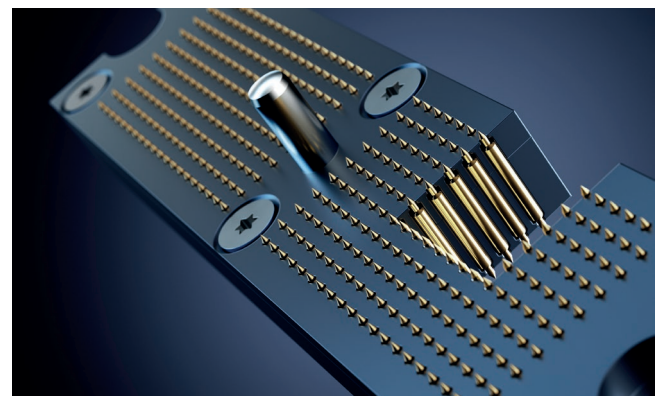

WLCSP SOLUTIONS X FEINPROBE®

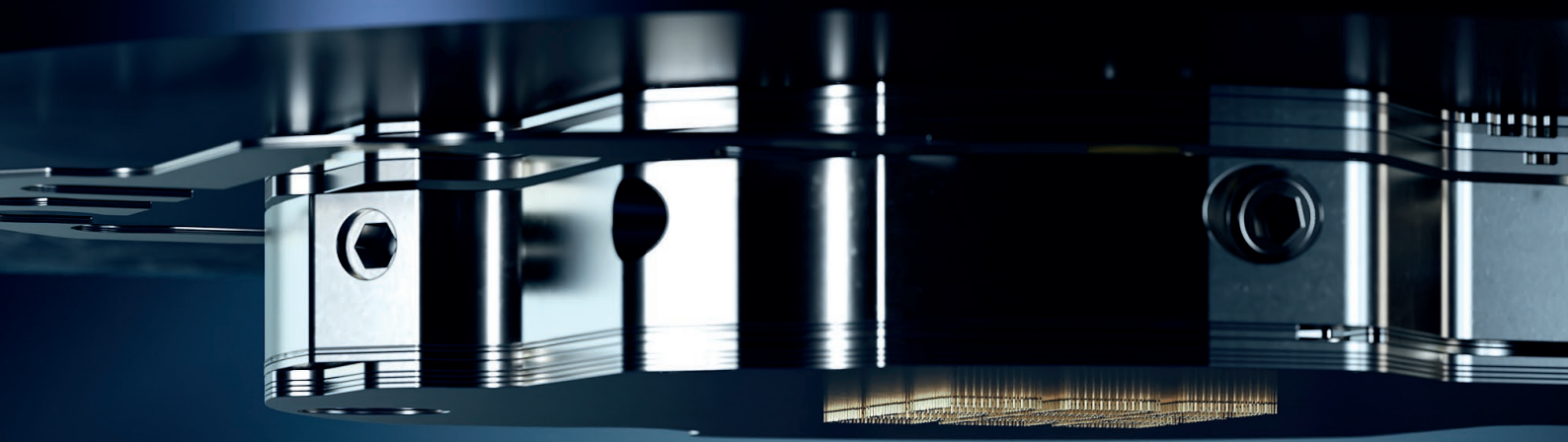

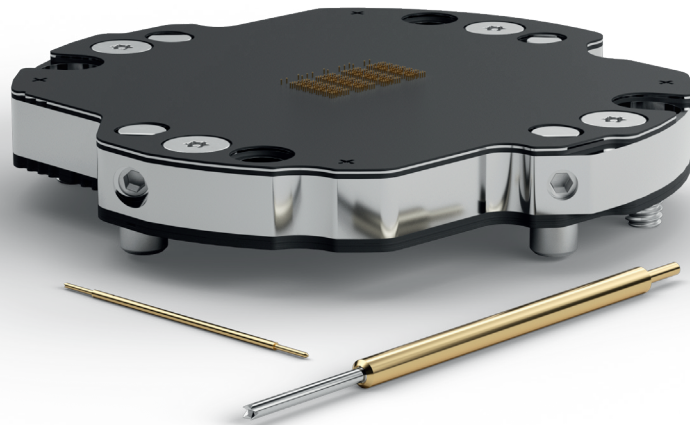

FEINPROBE®

The Spring Probe Solution

The FEINMETALL FeinProbe® uses contact probes as contact elements for contacting bumped wafers for WLCSP, SiP and Flip Chip Applications.

By using FEINMETALL contact probes, the probe solution has several advantages because of the independent spring loaded pins and the crown tip of the contact element. This ensures a stable contact without a stressful impact on the bumps. Even more, signal transmission can be guaranteed when applying specific design rules.

Advantages

- Stable contact performance in terms of low contact resistance and force
- Self-aligning plunger and crown tip reduces stress to the bump
- Spring probes are able to withstand higher currents
- Signal transmission of up to 80 GHz (when following specific layout rules)
- Combined know-how from FM spring probe department, special adaptations and wafer probe cards
- Fast delivery time due to automatic spring probe assembly
- High quality due to accurate ceramic design
- Easy maintenance
- 5G proven wafer testing technology

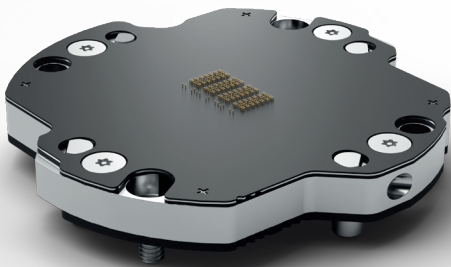

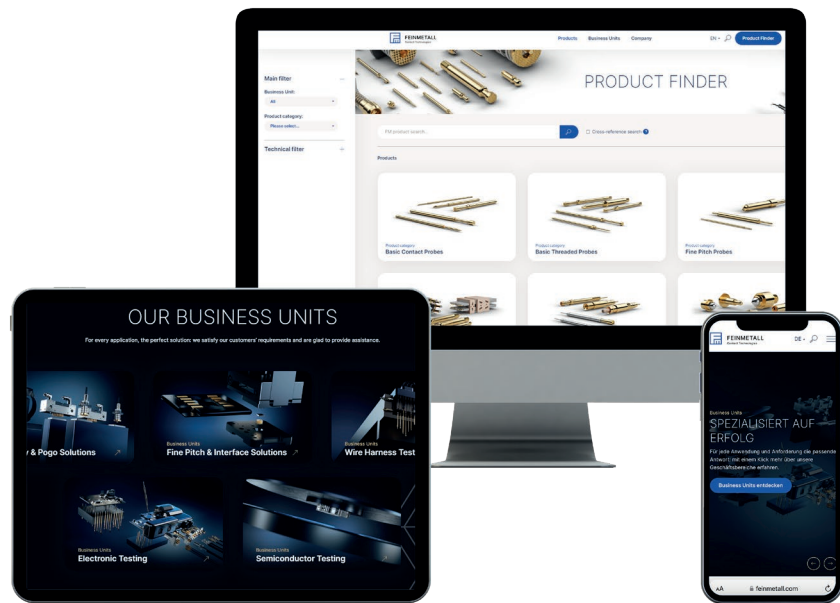

FIND US ONLINE

Our website

Welcome to the digital world of FEINMETALL. We offer you innovative contacting solutions that exceed your expectations. Visit our website at FEINMETALL.com and be inspired by the wide range of services customized to industry-specific needs. By using innovative technologies and advanced manufacturing methods, we deliver products of the highest quality and precision that can be used in various industries such as automotive, electronics, aerospace and medical. Our dedicated team is on hand to understand your requirements and help you to find the best solutions to your challenges.

> [FEINMETALL.COM](https://www.feinmetall.com)

Join the community

Connect with us on LinkedIn, Instagram and YouTube. We take you behind the scenes at FEINMETALL and offer exciting insights into the various areas of the company. With exciting content, we stay true to our passion for precision and technology. Receive regular updates about our company, including new product launches and developments, reports on events and trade fairs, company news and more. We'll also keep you up to date on new career opportunities and job openings. Connect with us now and become a part of our community. Stay up to date and don't miss out on more about FEINMETALL.

> [LINKEDIN.COM/COMPANY/FEINMETALL-GMBH](https://www.linkedin.com/company/feinmetall-gmbh)

> [INSTAGRAM.COM/FEINMETALL.GMBH](https://www.instagram.com/feinmetall.gmbh)

> [YOUTUBE.COM/@FEINMETALL](https://www.youtube.com/@feinmetall)





CHASING THE EDGE OF
WHAT IS POSSIBLE

PASSION
FOR FINEST
TECHNOLOGY.

> FEINMETALL.COM



1147211 - FEINMETALL GMBH | ZEPPELINSTRASSE 8 | D-71083 HERRENBERG